

GARMIN®

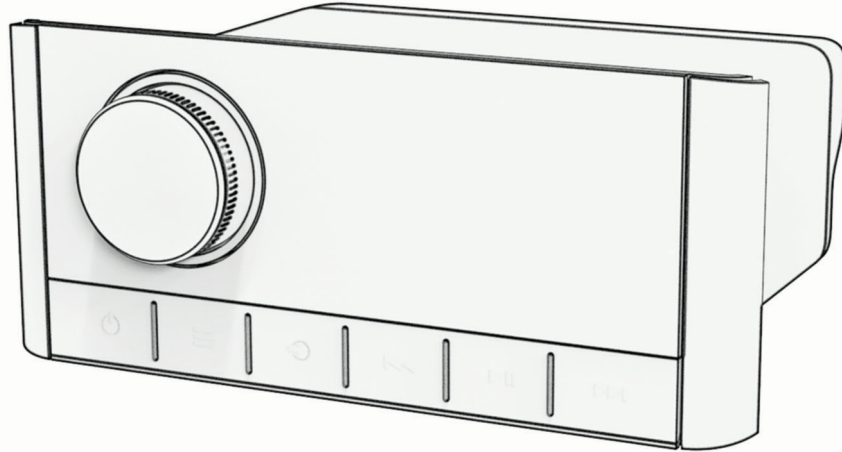

FUSION APOLLO™ MS-RA670

Owner's Manual

© 2019 Garmin Ltd. or its subsidiaries

All rights reserved. Under the copyright laws, this manual may not be copied, in whole or in part, without the written consent of Garmin. Garmin reserves the right to change or improve its products and to make changes in the content of this manual without obligation to notify any person or organization of such changes or improvements. Go to www.garmin.com for current updates and supplemental information concerning the use of this product.

Garmin®, Garmin BlueNet™, ANT®, Fusion®, and the Fusion logo are trademarks of Garmin Ltd. or its subsidiaries, registered in the USA and other countries. Fusion Apollo™, Connect IQ™, and Fusion PartyBus™ are trademarks of Garmin Ltd. or its subsidiaries. These trademarks may not be used without the express permission of Garmin.

Apple®, AirPlay®, iPhone®, and iPod touch® are trademarks of Apple Inc., registered in the USA and other countries. App Store™ is a service mark of Apple Inc., registered in the USA and other countries. Android™ and Google Play™ are trademarks of Google Inc. BLUETOOTH® word mark and logos are owned by the Bluetooth SIG, Inc. and any use of such marks by Garmin is under license. NMEA 2000® and the NMEA 2000 logo are registered trademarks of the National Marine Electronics Association. SiriusXM®, SportsFlash™, TuneMix™, TuneStart™, and all related marks and logos are trademarks of Sirius XM Radio Inc. All rights reserved. Other trademarks and trade names are those of their respective owners.

M/N: A03657 IC: 1792A-03657

Table of Contents

Getting Started	1	Controlling Music Playback on a Connected Apple Device.....	10
Stereo Controls.....	1	USB Source Settings.....	10
Entering Text.....	3	Radio	11
Using the Dial to Select Items.....	3	Setting the Tuner Region.....	11
Stereo Screen.....	3	Changing the Radio Station.....	11
Naming the Device.....	4	Apple AirPlay	12
Setting the Home Zone.....	4	Connecting an Apple Device Using AirPlay.....	12
Selecting a Source.....	4	Setting an AirPlay Password.....	12
Adjusting the Backlight and Dial Brightness.....	4	Connecting an Auxiliary Device	12
Audio Control	4	Optical Audio Connection	12
Adjusting the Volume.....	4	SiriusXM Satellite Radio	12
Muting all Connected Stereos.....	5	Setting the Tuner Region for the SiriusXM Source.....	13
Adjusting the Subwoofer Level.....	5	Locating the SiriusXM Radio ID.....	13
Adjusting the Tone.....	5	Activating a SiriusXM Subscription.....	13
Disabling the Loud Setting for a Zone.....	5	Selecting a Category.....	13
Adjusting the Gain for an Auxiliary Device.....	5	Using Replay Mode.....	13
Speaker Zones.....	5	Alerts.....	14
DSP Settings.....	6	Adding an Artist or Song Alert.....	14
Configuring the DSP Settings.....	6	Adding Teams for Game Alerts.....	14
Automatic Volume Adjustment Based on Speed.....	6	Adding Teams from a Live Game.....	14
Media Player Connection	7	Viewing Active Alerts.....	14
Bluetooth Device Playback	7	Managing Alerts.....	15
Connecting a Compatible Bluetooth Device.....	7	TuneMix™ Feature.....	15
Bluetooth Range Information.....	8	Starting and Stopping a TuneMix Collection.....	15
Selecting a Different Bluetooth Device.....	8	Creating and Customizing a TuneMix Collection.....	15
Bluetooth Source Menu and Settings....	8	SportsFlash Feature.....	16
Disabling Bluetooth Auto Connection.....	8	Adding Teams to Receive SportsFlash Alerts.....	16
USB Device Playback	9	Changing SportsFlash Team Priority.....	16
USB Device Compatibility.....	9	Enabling the TuneStart™ Feature.....	16
Connecting a USB Device.....	9	Parental Controls.....	16
Controlling Music Playback on a USB Flash Drive or Media Player.....	10	Unlocking the Parental Controls.....	17
Controlling Music Playback on a Connected Android Device.....	10	Locking Channels.....	17
		Clearing All Locked Channels.....	17
		Changing the Parental Control Passcode.....	17

SiriusXM Troubleshooting.....	18	Adjusting the Power-On Volume Limit.....	27
Clearing SiriusXM Data.....	18	Maintaining Individual Zone Volume Levels.....	27
DAB Playback.....	19	Enabling Automatic Volume Adjustment Based on Speed.....	27
Setting the Tuner Region.....	19	Automatic Volume Control Settings.....	28
Scanning for DAB Stations.....	19	Disabling a Zone.....	28
Changing DAB Stations.....	19	Setting a Zone Name.....	28
Selecting a DAB Station from a List.....	19	Linking Zones.....	29
Selecting a DAB Station from a Category.....	19	Enabling Volume Control of Zone 3 or 4 from a Connected Amplifier.....	29
Presets.....	20	Adjusting the Subwoofer Filter.....	29
Saving a Station or Channel as a Preset.....	20	Adjusting Additional Audio Settings for a Zone.....	29
Selecting a Preset from a List.....	20	Power Options.....	30
Removing Presets.....	20	Source Settings.....	30
Fusion PartyBus Networking.....	21	Network Settings.....	30
Creating a Group.....	21	Setting the Stereo as a Wired DHCP Server.....	30
Editing a Group.....	21	Setting a Static IP Address.....	31
Leaving a Group.....	21	DHCP Settings.....	31
Grouped Stereo Functions.....	22	Connecting the Stereo to a Garmin Network.....	31
Grouped Stereo Source Considerations.....	22	Resetting Network Settings.....	32
Group Synchronization.....	23	Update Options.....	32
Enabling Group Synchronization.....	23	Additional Stereo Control Options... 32	
LED Lighting Control.....	23	Connecting to a Garmin Watch.....	32
Turning LED Lights On and Off.....	24	Connecting to an ARX70 Remote Control.....	33
Turning on LED Light Effects.....	24	Fusion Audio Wireless Remote Control App.....	33
Starting an LED Light Scene.....	24	Fusion Stereo Network Connection and Control.....	33
Setting LED Lights to React to Music..	24	NMEA 2000 Remote Control and Display.....	34
LED Light Control and Configuration Using the ActiveCaptain App.....	25	Configuring an Optional Wired NRX Remote Control.....	34
Getting Started with the ActiveCaptain App.....	25	NMEA 2000 Information.....	34
Initializing Connected LED Lights Using the ActiveCaptain App.....	25	Appendix.....	34
General Settings.....	26	Registering Your Fusion Device.....	34
Speaker Zone Settings.....	26	Cleaning the Device.....	35
Disabling the Internal Amplifier.....	26	Software Updates.....	35
Setting the Home Zone.....	26	Updating the Software Using a USB Flash Drive.....	38
Synchronizing the Source and Zone Volume Levels.....	27		

Downloading a Software Update Manually	38
Downloading a Software Update using the Garmin Express App	39
Updating the Software from a Prepared USB Flash Drive	40
Updating the Software Using the Fusion Audio App	41
Network Update Options	42
Updating the Software as Part of a Garmin Network Update	42
Troubleshooting	42
The stereo does not respond to key presses	42
My Bluetooth audio is interrupted by short breaks	42
The stereo does not display all song information from my Bluetooth source	42
Network Troubleshooting	43
Network Status Icons	43
Software Update Troubleshooting ...	43
The stereo updates successfully, but a Garmin lighting controller does not	44
The stereo does not update as part of a Garmin network update	44
The stereo keeps locking up when connected to an Apple device	44
The stereo is not finding my connected Apple device	44
My Apple AirPlay audio is interrupted by short breaks	44
Specifications	45
Stereo Dimension Drawings	46
Side Dimensions	46
Top Dimensions	46







Getting Started

⚠ WARNING

See the *Important Safety and Product Information* guide in the product box for product warnings and other important information.





Stereo Controls



Dial	<ul style="list-style-type: none"> • Turn to adjust the volume. • When adjusting the volume, press to switch between zones. • Turn to move through the menus or adjust a setting. • When in a menu, press to select the highlighted option. • Press and hold to activate certain functions such as opening the radio presets or muting all connected stereos from the mute screen (Muting all Connected Stereos, page 5).
	<ul style="list-style-type: none"> • Press to turn on the stereo. • Press to mute the audio. • Press and hold to turn off the stereo or all stereos on the network. • Press and hold for longer than 10 seconds to reset the stereo.
	<ul style="list-style-type: none"> • Press to open the menu. • Press to return to the previous screen from the menu. • Press and hold to exit the menu.
	<p>Press to change the source.</p> <p>TIP: You can turn the dial to browse, and press the dial to select the source.</p> <p>Press and hold to open the GROUPS menu when connected to a Fusion PartyBus™ network (Fusion PartyBus Networking, page 21).</p>
	<ul style="list-style-type: none"> • Press to skip to the beginning of the track or to the previous track, when using an applicable source. • Press and hold to rewind the track, when using an applicable source. • AM/FM source: <ul style="list-style-type: none"> ◦ Press to tune to the previous station or preset. ◦ Press and hold for faster tuning (manual mode only). • AUX: Press to decrease the gain. • SiriusXM source: <ul style="list-style-type: none"> ◦ In Live Mode, press to tune to the previous station or preset. ◦ In Live Mode, press and hold for faster tuning, in Manual mode only. ◦ In Replay Mode, press to skip to the previous track. ◦ In Replay Mode, press and hold to rewind the current track. • DAB source: <ul style="list-style-type: none"> ◦ Press to return to the previous DAB station in the ensemble. When you reach the beginning of the current ensemble, the stereo automatically changes to the last available station in the previous ensemble. ◦ Press and hold to return to the previous DAB ensemble.
	<ul style="list-style-type: none"> • Press to pause or resume media playback. • AM/FM source: <ul style="list-style-type: none"> ◦ Press to cycle through the tuning modes (Auto, Manual, and Preset). ◦ Press and hold to save the selected station as a preset. • SiriusXM source: <ul style="list-style-type: none"> ◦ Press and hold to switch between Replay Mode and Live Mode. ◦ In Live Mode, press to cycle through the tuning modes (Manual, Category, and Preset). ◦ In Replay Mode, press to pause and play. • DAB source: <ul style="list-style-type: none"> ◦ Press and hold to scan for DAB stations. ◦ Press to switch between manual tuning mode and presets.
	<ul style="list-style-type: none"> • Press to skip to the next track or station, when using an applicable source. • Press and hold to fast-forward, when using an applicable source. • AM/FM: <ul style="list-style-type: none"> ◦ Press to tune to the next station or preset. ◦ Press and hold for faster tuning (manual mode only).

- AUX: Press to increase the gain.
- SiriusXM source:
 - In Live Mode, press to tune to the next station or preset.
 - In Live Mode, press and hold for faster tuning, in Manual mode only.
 - In Replay Mode, press to skip to the next track, if applicable.
 - In Replay Mode, press and hold to fast-forward the current track, if applicable.
- DAB source:
 - Press to advance to the next DAB station in the ensemble. When you reach the end of the current ensemble, the stereo automatically changes to the first available station in the next ensemble.
 - Press and hold to advance to the next DAB ensemble.

Entering Text

- 1 In a field that allows you to enter text, select  to erase the existing characters.
- 2 If necessary, select  or  to use numerals, symbols, or lower-case letters when available.
- 3 Turn the dial to choose a character, and press the dial to select it.
- 4 Select  to save the new text.

Using the Dial to Select Items





You can use the dial to highlight and select items on the screen.

- Turn the dial to highlight an item on the screen.
- Press the dial to select the highlighted option.

Stereo Screen

The information displayed on the screen varies depending on the source selected. This example shows a track playing on a device connected using Bluetooth® wireless technology.



	Source name
	Active zone and status icons (Network Status Icons , page 43)
	Track details (if available)
	Album art (if available from a compatible source)
	Elapsed time, track duration, and the current track number out of the total number of tracks in the playlist (if available)

Naming the Device

You should provide a unique name for this device so you can easily identify it when viewing devices on the Fusion PartyBus network.

NOTE: You should provide unique names for all of the devices and zones on the network to avoid confusion when grouping, controlling, and setting up stereos and zones. You should also turn off zones that are not in use ([Speaker Zone Settings, page 26](#)).

For further customization, you can provide unique names for the sources on each stereo and turn off unused sources ([General Settings, page 26](#)).

- 1 Select  > **SETTINGS**.
- 2 Select **DEVICE NAME**, and select an option:
 - Select a pre-defined name from the list.
 - Select **CUSTOM NAME**, and enter a unique name for the device.

Setting the Home Zone

The home zone is the speaker zone that you adjust by default when you turn the dial.

- 1 Select  > **SETTINGS**.
- 2 Select **ZONE** > **ASSIGN HOME ZONE**.
- 3 Select a zone.

Selecting a Source

- 1 Select .
- 2 Turn the dial to highlight a source.

NOTE: If the device is part of a group, continue turning the dial to access the sources on other devices in the group ([Creating a Group, page 21](#)).

If a source cannot be shared with the group, it will appear gray and you cannot select it.
- 3 Press the dial to select the source.

Adjusting the Backlight and Dial Brightness

NOTE: If you connected the dim wire on the wiring harness to the boat's illumination wire, the backlight and dial dim automatically when the boat lights are on. This may affect how you adjust the brightness setting.

- 1 Select  > **BRIGHTNESS**.
- 2 Adjust the brightness level.

Audio Control

Adjusting the Volume

Using this stereo, you can control the volume of any zone on any stereo connected to the Fusion PartyBus network.

- 1 Turn the dial to adjust the volume for the home zone on the stereo.
- 2 If necessary, press the dial to switch between zones.

NOTE: If this stereo is part of a group, you can adjust the volume of all stereos in the group or individual zones on each stereo ([Creating a Group, page 21](#)).

Muting all Connected Stereos

You can quickly mute the audio from this stereo or from all stereos connected to the Fusion PartyBus network ([Fusion PartyBus Networking, page 21](#)).

- 1 From any source, press .
The mute symbol appears and audio from this stereo is silenced.
NOTE: If the stereo is part of a group, the audio from all grouped stereos is silenced.
- 2 Press and hold the dial to select **MUTE SYSTEM**.
Audio from all connected stereos is silenced.
- 3 Press and hold the dial to select **UNMUTE SYSTEM**.
Audio is restored to all connected stereos.

Adjusting the Subwoofer Level

You can adjust the subwoofer level for each zone.

- 1 Press the dial, and select a zone with a connected subwoofer.
- 2 Press and hold the dial.
The SUB LEVEL adjustment for the zone appears.
- 3 Adjust the subwoofer level and press the dial to set it.

Adjusting the Tone

- 1 Select  > **AUDIO**.
- 2 Select the zone to adjust.
- 3 Press the dial to select a tone.
- 4 Adjust the tone level and press the dial to set it.



Disabling the Loud Setting for a Zone

The LOUD setting maintains frequency response at low volumes and increases perceived loudness at high volumes. This setting is enabled by default in all zones.

- 1 Select  > **AUDIO**.
- 2 Select a zone to adjust.
- 3 Select **LOUD** to clear the check box.

Adjusting the Gain for an Auxiliary Device

You can adjust the gain for a connected auxiliary device to achieve a volume level similar to that of other media sources. You can adjust the gain in 1 dB increments. You can also adjust the gain for digital sources using an optical audio connection.

- 1 Select an auxiliary source.
- 2 Select an option:
 - To increase the gain, select .
 - To decrease the gain, select .

NOTE: To achieve the best audio quality when using a portable media player with headphone output, it may be necessary to adjust the volume control on the media player, instead of adjusting the gain.

Speaker Zones

You can group speakers in one area into a speaker zone. This enables you to control the audio level of the zones individually. For example, you could make the audio quieter in the cabin and louder on deck.

You can set the balance, volume limit, tone, subwoofer frequency, and name for each zone, and configure other zone-specific settings ([Speaker Zone Settings, page 26](#)).

NOTE: Subwoofer frequency is not adjustable when managed by DSP.

DSP Settings

This stereo features digital signal processing (DSP). You can select pre-configured DSP settings for Fusion® speakers and amplifiers to optimize audio reproduction in their installed locations.

All DSP settings are configured using the Fusion Audio remote control app ([Fusion Audio Wireless Remote Control App, page 33](#)).

Configuring the DSP Settings

You must download and install the Fusion Audio remote control app on your compatible Apple® or Android™ device before you can configure the DSP settings ([Fusion Audio Wireless Remote Control App, page 33](#)).

You can configure the DSP settings to optimize the sound on each zone with the installed speakers, amplifiers, and environment.

- 1 From the settings menu on your Apple or Android device, connect to the stereo using Bluetooth technology or connect to the same wireless network as the stereo.

NOTE: If you have a compatible Apple device, you can use a Lightning™ to USB sync cable (sold separately) connected to the USB port on the stereo and to your Apple device to configure the DSP settings using the Fusion Audio app.

- 2 Open the Fusion Audio remote control app on your compatible Apple or Android device.

- 3 If necessary, select the stereo you want to configure.

- 4 Select .

- 5 If necessary, select the **MUSIC** tab.

- 6 Select a zone.

- 7 Select **DSP SETTINGS**.

- 8 Configure the DSP settings as needed, depending on the models of Fusion speakers and amplifiers connected to the zone.

- 9 Select **SEND DSP SETTINGS**.

NOTE: DSP settings or updates for the zone are not applied on the stereo until you select the button to send the settings.

- 10 Repeat these steps for each zone.

Automatic Volume Adjustment Based on Speed

If your stereo is connected to a NMEA 2000® network with a device that provides speed information such as an engine, chartplotter, GPS antenna, water speed sensor, or wind speed sensor, you can set the stereo to adjust the volume automatically based on the selected speed source ([Enabling Automatic Volume Adjustment Based on Speed, page 27](#)).

For example, if a chartplotter with an internal GPS antenna or a stand-alone GPS antenna is on the same NMEA 2000 network as the stereo and you set the SPEED SOURCE to SPEED OVER GROUND, the volume increases as your speed increases.

NOTE: When the volume increases to adjust for speed, the actual volume output changes, but the volume-level indicator bar and number stays the same.

For more information about connecting the stereo to a NMEA 2000 network, see the installation instructions for your stereo.

Media Player Connection

WARNING

Minimize interaction with the media player display while operating the vessel, because doing so can cause distraction that could lead to an accident resulting in serious personal injury or death.

NOTICE

Always disconnect your media player from the stereo when not in use and do not leave it in your vessel. This can help reduce the risk of theft and damage from extreme temperatures.

The stereo accepts a variety of media players, including smartphones and other mobile devices. If it is supported by your compatible media player, you can connect it to the stereo using a Bluetooth wireless connection. If it is supported by your compatible media player, you can connect it using a cable with a USB A connector to the USB port on the stereo. The stereo can play media from a compatible Apple device connected to the same network using the AirPlay® feature.

Bluetooth Device Playback

You can pair the stereo to up to eight Bluetooth media devices.

You can control the playback using the stereo controls on all Bluetooth devices, and on some devices you can browse the music collection from the menu on the stereo.

On Bluetooth devices that do not support media browsing, you should select the song or playlist on the media device.

The availability of song information such as song title, artist name, track duration, and album art depends on the capability of the media player and music application.

Connecting a Compatible Bluetooth Device

You can play media from a compatible Bluetooth device using the Bluetooth wireless connection.

You can control the music playback with the media app on a Bluetooth device or using the Fusion Audio remote control app ([Fusion Audio Wireless Remote Control App, page 33](#)).

- 1 Select the **BLUETOOTH** source.
- 2 Select  > **BLUETOOTH** > **CONNECTIONS** > **DISCOVERABLE** to make the stereo visible to your compatible Bluetooth device.
- 3 Enable Bluetooth on your compatible Bluetooth device.
- 4 Bring the compatible Bluetooth device within 10 m (33 ft.) of the stereo.
- 5 On your compatible Bluetooth device, search for Bluetooth devices.
- 6 On your compatible Bluetooth device, select the stereo from the list of detected devices.

NOTE: The stereo appears in the Bluetooth device list as the device name (the default name is MS-RA670 unless it was changed in the settings).

- 7 On your compatible Bluetooth device, follow the on-screen instructions to pair and connect to the discovered stereo.

When pairing, your compatible Bluetooth device may ask you to confirm a code on the stereo. If the stereo shows a code, you can compare them before pairing. If the stereo does not display a code, it should connect correctly when you confirm the message on the Bluetooth device.

- 8 If your compatible Bluetooth device does not immediately connect to the stereo, repeat steps 1 through 7.
NOTE: If another Bluetooth device is already playing music on the stereo, connecting a new device will not interrupt playback. You must select the newly-added device if you want to use it instead ([Selecting a Different Bluetooth Device, page 8](#)).

The DISCOVERABLE setting is disabled automatically after two minutes.

NOTE: On some Bluetooth devices, adjusting the volume on the device affects the volume level on the stereo.

Bluetooth Range Information

The stereo and Bluetooth wireless devices have a range of 10 m (33 ft.). For optimal performance, the Bluetooth wireless device should also have a clear line of sight to the stereo.

Selecting a Different Bluetooth Device

When you have more than one Bluetooth device paired to the stereo, you can select a different device when needed. You can pair the stereo with up to eight Bluetooth devices.

- 1 With the **BLUETOOTH** source selected, select  > **BLUETOOTH** > **CONNECTIONS** > **PAIRED DEVICES**.
- 2 Select a Bluetooth device.

Bluetooth Source Menu and Settings

With the **BLUETOOTH** source selected, select  > **BLUETOOTH**.

NOTE: The options in this menu vary based on the connected device.

CONNECTIONS > DISCOVERABLE: Allows the stereo to be visible to Bluetooth devices. You can turn off this setting to prevent possible interruption to audio after pairing a Bluetooth device to the stereo.

CONNECTIONS > PAIRED DEVICES: Shows a list of Bluetooth devices paired with the stereo. You can select a device in the list to connect it to the stereo if it is in range.

CONNECTIONS > REMOVE DEVICE: Removes the Bluetooth device from the stereo. To listen to audio from this Bluetooth device again, you must pair the device again.

NOTE: You should also remove the stereo from the list of paired devices on your Bluetooth device to avoid connection issues when pairing the device again.

REPEAT: Sets the repeat mode for the current selection (Apple devices only). You can repeat the current selection by selecting the **REPEAT ONE** option. You can repeat all items in the selection by selecting the **REPEAT ALL** option.

SHUFFLE: Shuffles the tracks in the folder, album, or playlist (Apple devices only).

PLAYLIST: Displays the playlists on the device (Apple devices only).

ARTISTS: Displays the artists on the device (Apple devices only).

ALBUMS: Displays the albums on the device (Apple devices only).

GENRES: Displays the genres of music on the device (Apple devices only).

SONGS: Displays the songs on the device (Apple devices only).

APPLE MUSIC RADIO: Displays the Apple Music Radio stations on the device (Apple devices only).

Disabling Bluetooth Auto Connection

By default, the stereo automatically reconnects to the last connected Bluetooth device when you turn it on. You can disable this setting.

Select  > **SETTINGS** > **SOURCE** > **BLUETOOTH** > **AUTO CONNECT**.

When the **AUTO CONNECT** checkbox is clear, the stereo will not attempt to automatically reconnect to a Bluetooth device. When this feature is disabled, you must select a Bluetooth device manually to connect it ([Selecting a Different Bluetooth Device, page 8](#)).

USB Device Playback

You can connect various USB media players, USB flash drives, and smartphones to the stereo. How you access the USB source depends on the type of connected media player or smartphone.

Media Player	Source Selections
Android device	MTP
Apple device	iPod
USB flash drive	USB
MP3 media player (as a mass-storage device)	USB NOTE: If your MP3 media player does not support mass-storage when connected using USB, you must connect it to the stereo as an auxiliary device (Connecting an Auxiliary Device, page 12).

You can control the playback using the stereo controls on all USB devices, and on some devices you can browse the music collection from the menu on the stereo. On USB devices that do not support media browsing, you should select the song or playlist on the media device.

The availability of song information such as song title, artist name, and track duration depends on the capability of the media player and music application.

USB Device Compatibility

You can use a USB flash drive or the USB cable included with your media player to connect a media player or mobile device to the USB port.

The stereo is compatible with iAP2 Apple devices.

The stereo is compatible with Android devices that support MTP mode.

The stereo is compatible with media players and other USB mass storage devices, including USB flash drives. Music on USB drives must meet these conditions:

- The music files must be formatted as MP3, AAC (.m4a), or FLAC, files.
- If you connect a portable hard drive, you must connect it to an external power source. The USB port on this stereo cannot provide power for a portable hard drive.
- The USB mass storage device must be formatted using one of the following systems:
 - Microsoft®: NTFS, VFAT, FAT¹, MSDOS
 - Apple: HFS, HFSPLUS
 - Linux: EXT2, EXT3, EX4

Connecting a USB Device

You can connect a USB device to the USB port on the stereo.

- 1 Locate the USB port on the back of the stereo.
- 2 Connect the USB device to the USB port.

¹ FAT includes most types of FAT file systems except exFAT.

Controlling Music Playback on a USB Flash Drive or Media Player

- 1 Connect a compatible USB flash drive or media player to the stereo.
- 2 Select the **USB** source.
- 3 Select  > **USB**.
- 4 Select the name of the USB device.
- 5 Browse the music files on the device and begin playback.

You can use the stereo controls to select, play, pause, and skip tracks.

TIP: If the USB media player has a screen and controls, you can use the controls on the USB media player to control playback.

Controlling Music Playback on a Connected Android Device

You can connect an Android device to the stereo using a USB cable to play media files stored on the Android device. To play media from an app on the Android device, you should connect the device using Bluetooth technology instead ([Bluetooth Device Playback, page 7](#)).

- 1 Connect a compatible Android device to the stereo using an appropriate USB cable.
- 2 If necessary, enable USB file transfer or MTP on your Android device.
See the documentation available for your Android device for more information.
- 3 Select the **MTP** source on the stereo.
- 4 Select  > **MTP**.
- 5 Browse the music files on the Android device and begin playback.

You can use the stereo controls to select, play, pause, and skip tracks.

Controlling Music Playback on a Connected Apple Device

- 1 Connect a compatible iAP2 Apple device to the stereo using USB.
- 2 Select the **iPod** source on the stereo.
- 3 Launch a music application on the connected Apple device, and begin playback.

You can use the music application on the Apple device or you can use the stereo controls to browse the music library and to select, play, pause, and skip tracks.

USB Source Settings

With a USB device connected and a USB source selected, select the USB source type by pressing  then select the appropriate device.

NOTE: You can browse the files on the device using this menu. The options in this menu vary based on the connected device.

REPEAT: For a USB or MTP source, select to start playing the tracks in the list from the beginning after the last track has played.

For an iPod source, select REPEAT ONE to repeat the current track, or select REPEAT ALL to start playing the tracks in the folder, album, or playlist from the beginning after the last track has played.

SHUFFLE: For a USB or MTP source, select to randomly play the tracks in the list.

For an iPod source, select to randomly play the tracks in the folder, album, or playlist.

Radio

To listen to AM or FM radio, you must have a suitable marine AM/FM antenna properly connected to the stereo and be within range of a broadcasting station. For instructions on connecting an AM/FM antenna, see the stereo installation instructions.

To listen to SiriusXM® radio, you must have the appropriate equipment and subscriptions ([SiriusXM Satellite Radio, page 12](#)). For instructions on connecting a SiriusXM Connect Vehicle Tuner, see the stereo installation instructions.

To listen to DAB stations, you must have the appropriate equipment ([DAB Playback, page 19](#)). For instructions on connecting a DAB adapter and antenna, see the installation instructions provided with your adapter and antenna.

Setting the Tuner Region

You must select the region you are in to receive AM and FM stations properly.

If you are connected to a compatible SiriusXM tuner and antenna, and have a subscription (USA only), you must select the region you are in to receive SiriusXM stations properly.

NOTE: SiriusXM service is not available in all regions.



You must select the region you are in to receive DAB stations properly.

NOTE: You must connect a compatible DAB module and antenna (not included), to receive DAB stations.

DAB stations are not available in all regions.

- 1 Select  > **SETTINGS**.
- 2 Select **TUNER REGION**.
- 3 Select the region you are in.

Changing the Radio Station

- 1 Select an applicable source, such as **FM**.
- 2 Select  repeatedly to move through the tuning modes, and select an option:
 - Select **AUTO** to scan and stop on the next available station.
 - Select **MANUAL** to select a station manually.
 - Select **PRESET** to select a saved station preset.
- 3 Select  or  to tune to the station.



When in MANUAL tuning mode, you can hold  or  to quickly advance through the stations.

Apple AirPlay

Connecting an Apple Device Using AirPlay

- 1 From the settings menu on your Apple device, connect to the same wireless network as your compatible Fusion stereo.

NOTE: You can connect some Apple devices to the network using a wired Ethernet connection, if applicable. Go to the Apple website for more information.

- 2 On your Apple device, open the music app you want to stream to the stereo.
- 3 From the music app or program, select  or , and select the name of the stereo.
- 4 If necessary, start playing music on the app.

The stereo changes to the AirPlay source automatically and plays audio from your Apple device.

NOTE: If your Apple device is using AirPlay 2 software, you can connect to multiple stereos on the same network.

NOTE: You cannot stream the AirPlay source to other stereos on the network using the Fusion PartyBus network (*Fusion PartyBus Networking, page 21*). Using AirPlay 2 software, you can play content on multiple stereos on the network, but the stereos must not be grouped.

NOTE: On some AirPlay devices, adjusting the volume on the device affects the volume level on the stereo.

Setting an AirPlay Password

You can set a password that a user must enter when connecting to the stereo using the AirPlay feature.

- 1 Select  > **SETTINGS** > **SOURCE** > **AirPlay** > **AirPlay PASSWORD**.
- 2 Enter a password.

NOTE: The AirPlay password is case-sensitive.

When connecting to this stereo using the AirPlay feature, the user must enter the password on their Apple device.

Connecting an Auxiliary Device

You can connect various auxiliary devices to the stereo. These devices have either RCA connectors, a line output, or a headphone output jack.

- 1 Locate the auxiliary connectors on the wiring harness.
- 2 If necessary, connect an RCA-to-3.5 mm adapter cable to the auxiliary device.
- 3 Connect the auxiliary device to the AUX IN RCA connectors on the wiring harness.
- 4 Select the **Aux** source.

Optical Audio Connection

You can connect devices with an optical audio output to the stereo using an optical audio cable. Televisions, DVD players, CD players, and other devices may supply digital optical audio output.

This stereo supports PCM audio only. You may have to change the settings on your device to output PCM audio.

NOTE: Because streaming audio over the Fusion PartyBus network introduces a slight delay, streaming content from a television or DVD player may not be ideal. You can disable Optical as a streaming source in the settings or disable the GROUP feature, if needed (*Source Settings, page 30*).

SiriusXM Satellite Radio

Only SiriusXM brings you more of what you love to listen to, all in one place. Get over 140 channels, including commercial-free music plus the best sports, news, talk, comedy and entertainment. Welcome to the world of satellite radio. A SiriusXM Vehicle Tuner and subscription are required. For more information, go to www.siriusxm.com.

Setting the Tuner Region for the SiriusXM Source

You must set the stereo to use the USA tuner region before you can listen to SiriusXM Satellite Radio.

Select  > **SETTINGS** > **TUNER REGION** > **USA**.

Locating the SiriusXM Radio ID

You must have the radio ID of your SiriusXM Connect Tuner before you can activate your SiriusXM subscription. You can locate the SiriusXM Radio ID on the back of the SiriusXM Connect Tuner or its packaging, or by tuning your stereo to channel 0.

With the SiriusXM source selected, select  > **SiriusXM** > **CHANNELS** > **ALL CHANNELS** > **000 RADIO ID**.

The SiriusXM Radio ID does not include the letters I, O, S, or F.

Activating a SiriusXM Subscription

- 1 With the SiriusXM source selected, tune to channel 1.

You should be able to hear the preview channel. If not, check the SiriusXM Connect Tuner and antenna installation and connections, and try again.

- 2 Tune to channel 0 to locate the Radio ID.

- 3 Contact SiriusXM listener care by phone at (866) 635-2349 or go to www.siriusxm.com/activatenow to subscribe in the United States. Contact SiriusXM by phone at (877) 438-9677 or go to www.siriusxm.ca/activatexm to subscribe in Canada.

- 4 Provide the Radio ID.

The activation process usually takes 10 to 15 minutes, but can take up to an hour. For the SiriusXM Connect Tuner to receive the activation message, it must be turned on and receiving the SiriusXM signal.

- 5 If the service is not activated within the hour, go to <http://care.siriusxm.com/refresh> or contact SiriusXM Listener Care by phone at 1-866-635-2349.

Selecting a Category

You can control which categories of channels are available when using the CATEGORY tuning method.

- 1 With the SiriusXM source selected, select  > **SiriusXM** > **CATEGORY**.

- 2 Select a category.

Using Replay Mode



You can use Replay Mode to control playback of a SiriusXM broadcast.

NOTE: The device enables Replay Mode automatically when playing saved preset channels.



- 1 If necessary, hold  to enable Replay Mode.

A progress bar appears at the bottom of the screen.

- 2 Select an option:

- Press  to pause and resume playback.
- Press  or  to skip backward or forward in increments.

NOTE: If you fast-forward or skip forward to the end of the progress bar, the stereo exits Replay Mode automatically.

- Hold  or  to rewind or fast-forward the track.
- Hold  to exit Replay Mode.

Alerts

WARNING

Minimize interaction with the stereo or media player while operating the vessel, because doing so can cause distraction which could lead to an accident causing serious personal injury or death.

NOTE: The Artist, Song, and Game Alerts feature is compatible with the SXV300 tuner (sold separately). Other tuners are compatible, but may limit the features. Review the user manual supplied with your SiriusXM tuner to learn about features available with your tuner module.

Adding an Artist or Song Alert

You can set alerts for artists and songs so that when a particular song or a song from a particular artist begins to play on any music channel, you can quickly tune to that channel.

- 1 While a particular song or a song from a particular artist is playing, select  > **SiriusXM** > **ADD ALERT** > **SAVE ARTIST/SONG**.
- 2 Select the song or the artist.

Adding Teams for Game Alerts

You can set alerts for sports teams so that when a game featuring a saved team begins to play on any sports channel, you can quickly tune to that channel.

NOTE: A Game Alert is different than a SportsFlash™ alert. A Game Alert lets you know when a game begins, while a SportsFlash alert lets you know when an exciting play occurs during a game.

- 1 Select  > **SiriusXM** > **ADD ALERT** > **GAME ALERT TEAMS**.
- 2 Select a sports league.
- 3 Select a team to fill the check box and add a Game Alert.
- 4 Repeat steps 2 and 3 for each team you want to add to the list of Game Alerts.

Adding Teams from a Live Game

While listening to a game, you can quickly add a team playing to your list of Game Alert teams.

- 1 While listening to a game on a channel, select  > **SiriusXM** > **ADD ALERT** > **SAVE TEAM**.
A list of teams playing in the current game appears.
- 2 Select the team or teams to add to your list of Game Alert teams.

Viewing Active Alerts

You can review active Artist, Song, and Game Alerts.

- 1 Select  > **SiriusXM** > **ACTIVE ALERTS**.
- 2 Select a category.

Managing Alerts

You can manage your saved alerts to select which ones you want to receive. You can delete saved alerts you do not want.

- 1 Select  > **SiriusXM** > **SXM SETTINGS** > **ALERT MANAGEMENT**.
- 2 Select an option:
 - To enable saved alerts for songs only, artists only, or games only, select **ENABLE BY TYPES**, and select a type.
 - To enable saved alerts for specific artists only, select **ENABLE ARTISTS**, and select the artists.
 - To enable saved alerts for specific songs only, select **ENABLE SONGS**, and select the songs.
 - To enable saved game alerts for specific teams, select **ENABLE TEAMS**, and select the teams.
 - To delete all saved alerts for songs, artists, or teams, select **DELETE BY TYPES**, and select a type.
 - To delete saved alerts for specific artists, select **DELETE ARTISTS**, and select the artists.
 - To delete saved alerts for specific songs, select **DELETE SONGS**, and select the songs.
 - To delete saved alerts for specific teams, select **DELETE TEAMS**, and select the teams.

TuneMix™ Feature

NOTE: The TuneMix feature is compatible with the SXV300 tuner (sold separately). Other tuners are compatible, but may limit the features. Review the user manual supplied with your SiriusXM tuner to learn about features available with your tuner module.

Starting and Stopping a TuneMix Collection

Before you can start playing a TuneMix collection, you must create one ([Creating and Customizing a TuneMix Collection, page 15](#)).

The TuneMix feature enables you to mix your favorite music channels to create a custom listening experience.

- 1 Select  > **SiriusXM** > **TUNEMIX**.
- 2 Select a TuneMix collection.



The stereo begins playing the TuneMix collection.
- 3 To stop playing a TuneMix collection, select  > **CHANNELS**, and select a channel.

The stereo stops playing the TuneMix collection and begins playing the selected channel.

Creating and Customizing a TuneMix Collection

You can create up to 10 unique TuneMix collections on the stereo.

NOTE: A TuneMix collection must include at least two of your favorite SiriusXM music channels.

- 1 Select  > **SiriusXM** > **SXM SETTINGS** > **TUNEMIX SETUP**.
- 2 Select a TuneMix collection.
- 3 Select a channel to fill the check box and add it to the TuneMix collection.
- 4 After you are finished customizing the TuneMix collection, select .
- 5 Repeat steps 2 through 4 for each TuneMix collection you want to customize.

SportsFlash Feature

WARNING

Minimize interaction with the stereo or media player while operating the vessel, because doing so can cause distraction which could lead to an accident causing serious personal injury or death.

The SportsFlash feature alerts you to key plays from your favorite teams during a live game. When an exciting play happens, a SportsFlash alert appears, and you can tune to the broadcast and hear the play. When the SportsFlash alert ends, you can choose to return to the previous channel, or remain tuned to the game.

NOTE: To receive SportsFlash alerts, your subscription package must include play-by-play sports channels for the sports leagues you want to include in the alerts.

You can enable, disable, or delete SportsFlash alerts that you have added ([Managing Alerts, page 15](#)).

NOTE: A SportsFlash is different than a Game Alert. A SportsFlash alert lets you know when an exciting play occurs during a game, while a Game Alert lets you know when a game begins.

NOTE: The SportsFlash feature is compatible with the SXV300 tuner (sold separately). Other tuners are compatible but may limit the features. Review the user manual supplied with your SiriusXM tuner to learn about features available with your tuner module.

Adding Teams to Receive SportsFlash Alerts

- 1 Select  > **SiriusXM** > **SPORTSFLASH** > **TEAM SELECT**.
- 2 Select a sports league.
- 3 Select a team to fill the check box and add a SportsFlash alert.
- 4 Repeat steps 2 and 3 for each team you want to add to the list of SportsFlash alerts.

Changing SportsFlash Team Priority

If more than one team for which you have set up SportsFlash alerts are playing at the same time, you can adjust the team priority to hear SportsFlash alerts from your preferred team first.

- 1 Select  > **SiriusXM** > **SPORTSFLASH** > **TEAM PRIORITIES**.
A list of your selected SportsFlash teams appears, in order of priority.
- 2 Select a team to move it up one priority level in the list.
- 3 Repeat the previous step with each team you want to reorder until the priority list is ordered the way you prefer.

Enabling the TuneStart™ Feature

When you enable the TuneStart feature and tune to a preset channel, the stereo starts the current song from the beginning of the song instead of starting it from the point it is at in the live broadcast.

NOTE: The TuneStart feature is available when tuning to preset channels only. The TuneStart feature is compatible with the SXV300 tuner (sold separately). Other tuners are compatible but may limit the features. Review the user manual supplied with your SiriusXM tuner to learn about features available with your tuner module.

If necessary, select  > **SiriusXM** > **SXM SETTINGS** > **TUNESTART**.

When the TuneStart feature starts a song from the beginning, a progress bar appears and you can control the track using the same controls as Replay Mode ([Using Replay Mode, page 13](#)).

Parental Controls

The parental control feature allows you to limit access to any SiriusXM channels, including those with mature content. When the parental control feature is enabled, you must enter a passcode to tune to the locked channels. You can also change the 4-digit passcode.

Unlocking the Parental Controls

You can unlock the parental controls to access locked channels.

- 1 With the **SiriusXM** source selected, select  > **SiriusXM** > **PARENTAL**.
- 2 Select **UNLOCK**.
- 3 Enter the passcode.

TIP: The default passcode is 0000.

The parental controls remain unlocked until you turn off the vehicle or until you lock them again.

Locking Channels



- 1 With the **SiriusXM** source selected, select  > **SiriusXM** > **PARENTAL**.
- 2 Select the **UNLOCK** check box.
- 3 Enter the passcode.
- 4 Select **LOCK/UNLOCK**.

A list of available channels appears.



- 5 Select one or more channels to lock, and select .
- 6 Clear the **UNLOCK** check box to lock the parental controls.

You cannot access the locked channels while the parental controls are locked. You must unlock the parental controls to tune the locked channels.

Clearing All Locked Channels

- 1 With the **SiriusXM** source selected, select  > **SiriusXM** > **PARENTAL** > **UNLOCK**.
- 2 Enter the passcode.
- 3 Select  > **SiriusXM** > **PARENTAL** > **CLEAR ALL LOCKED**.

Changing the Parental Control Passcode

- 1 With the **SiriusXM** source selected, select  > **SiriusXM** > **PARENTAL** > **UNLOCK**.
- 2 Enter the passcode.
- 3 Select  > **SiriusXM** > **PARENTAL** > **CHANGE PIN**.
- 4 Follow the on-screen instructions.

SiriusXM Troubleshooting

Advisory	Description	Resolutions
Check Antenna	The radio has detected a fault with the SiriusXM antenna. The antenna cable may be disconnected or damaged.	<ul style="list-style-type: none"> Verify the antenna cable is connected to the SiriusXM Connect Vehicle Tuner. Inspect the antenna cable for damage and kinks. Replace the antenna if the cable is damaged. SiriusXM products are available at your local car audio retailer, or at www.shop.siriusxm.com.
Check Tuner	The stereo is having difficulty communicating with the SiriusXM Connect Vehicle Tuner. The tuner may be disconnected or damaged.	Verify the SiriusXM Connect Vehicle Tuner cable is connected securely to the stereo.
No Signal	The SiriusXM Connect Vehicle Tuner is having difficulty receiving the SiriusXM satellite signal.	<ul style="list-style-type: none"> Verify the SiriusXM antenna is outdoors with a clear view of the sky. Verify the SiriusXM antenna is mounted securely. Remove obstructions above or next to the SiriusXM antenna. Inspect the cable antenna for damage and kinks. Replace the antenna if the cable is damaged. SiriusXM products are available at your local car audio retailer or at www.shop.siriusxm.com. Consult the SiriusXM Connect Vehicle Tuner installation instructions for more information on antenna installation.
Subscription Updated	The radio has detected a change in your SiriusXM subscription status.	<ul style="list-style-type: none"> Select any button to clear the message. Go to www.siriusxm.com or call 866-635-2349 with questions about your subscription.
Channel Not Available	The channel you requested is not a valid SiriusXM channel, or the channel that you were listening to is no longer available. You may see this message briefly the first time you connect a new SiriusXM Connect Vehicle Tuner.	Go to www.siriusxm.com for more information about the SiriusXM channel lineup.
Channel Not Subscribed	The channel you requested is not included in your SiriusXM subscription package, or the channel you were listening to is no longer included in your SiriusXM subscription package.	Go to www.siriusxm.com or call 866-635-2349 for more information about your subscription package or to subscribe to the channel.
Channel Locked	The channel you requested is locked by the parental control feature.	Refer to the parental control section in the owner's manual to unlock channels.

Clearing SiriusXM Data

You can clear all entered SiriusXM user information, such as favorite teams and alerts.

Use the **FACTORY RESET** option in the settings menu to reset the stereo ([Update Options, page 32](#)).

NOTE: The factory reset setting resets all data in the stereo, including AM and FM presets, zone settings, etc. in addition to clearing all SiriusXM user information.

DAB Playback

When you connect the MS-DAB100A module and antenna to the Fusion Apollo RA670 stereo, you can tune in to and play DAB stations. For instructions on connecting the DAB adapter and antenna, see the installation instructions provided with your adapter and antenna.

DAB broadcasts are not available in all regions. When the stereo is not set to a compatible region, the DAB source is not available.

Setting the Tuner Region

You must select the region you are in to receive DAB stations properly.

- 1 Select  > **SETTINGS**.
- 2 Select **TUNER REGION**.
- 3 Select the region you are in.

Scanning for DAB Stations

Before you can scan for DAB stations, you must connect a compatible DAB module and antenna (not included) to the stereo.



NOTE: Because DAB signals are broadcast in select countries only, you must set the tuner region to a location where DAB signals are broadcast.

- 1 Select the **DAB** source.
- 2 Hold  to scan for available DAB stations.

When scanning is complete, the first available station in the first ensemble found begins playing.

NOTE: After the first scan is complete, you can hold  again to re-scan for DAB stations. When the re-scan is complete, the system starts playing the first station in the ensemble you were listening to when you started the re-scan.



Changing DAB Stations

- 1 Select the **DAB** source.
- 2 If necessary, hold  to scan for local DAB stations.
- 3 Select  or  to change the station.



When you reach the end of the current ensemble, the stereo automatically changes to the first available station in the next ensemble.

TIP: You can hold  or  to change the ensemble.

Selecting a DAB Station from a List

- 1 Select the **DAB** source.
- 2 If necessary, hold  to scan for local DAB stations.
- 3 Select  > **DAB** > **BROWSE** > **STATIONS**.
- 4 Select a station from the list.

Selecting a DAB Station from a Category

- 1 Select the **DAB** source.
- 2 If necessary, hold  to scan for local DAB stations.
- 3 Select  > **DAB** > **BROWSE** > **CATEGORIES**.
- 4 Select a category from the list.
- 5 Select a station from the list.

Presets

You can save your favorite AM stations and FM stations as presets for easy access.

You can save your favorite SiriusXM channels if the stereo is connected to an optional SiriusXM tuner and antenna.

You can save your favorite DAB stations if the stereo is connected to the proper DAB equipment and set to the correct tuner region. (*DAB Playback*, page 19)

Saving a Station or Channel as a Preset

- 1 With an applicable source selected, tune the stereo to a station or a channel.
- 2 Press and hold the dial, and select .

TIP: For the AM, FM, or SiriusXM source, you can press and hold  to save the current station or channel as a preset.

TIP: You can also select  the name of the source, and **PRESETS > SAVE CURRENT** to save the current station or channel as a preset.

Selecting a Preset from a List

- 1 With an applicable source selected, press and hold the dial.

TIP: You can also select  the name of the source, and **PRESETS > VIEW PRESETS** to view the list of presets.

- 2 Select a preset.

Removing Presets

- 1 With an applicable source selected, press and hold the dial.

- 2 Select .

- 3 Select each preset station or channel you want to remove.

- 4 When you are finished removing presets, select .

TIP: You can also select  the name of the source, and **PRESETS > REMOVE PRESETS** or **REMOVE ALL PRESETS** to remove preset stations or channels.

- 5 Press the dial to exit the screen.

Fusion PartyBus Networking

The Fusion PartyBus networking feature allows you to connect multiple compatible stereos together on a network, using a combination of wired or wireless connections.

NOTE: When you connect a Fusion stereo to Garmin BlueNet™ network or a Garmin® Marine Network, you are limited to using only Garmin and Fusion devices. You may not be able to use third-party routers, storage devices, or other network products with this stereo directly.

TIP: When the stereo is connected to a Garmin BlueNet network or a Garmin Marine Network, you can connect a mobile device to a wireless access point on a connected Garmin chartplotter and use the Fusion Audio app to control the stereo.

The Fusion Apollo RA670 stereo does not have built-in Wi-Fi® technology. To use the wireless functions of the network, you must connect the stereo to the network using a wired Ethernet connection.

You can group a compatible stereo, such as the Fusion Apollo RA670 stereo, with other compatible stereos connected to the Fusion PartyBus network. Grouped stereos can share available sources and control media playback on all of the stereos in the group, which allows for a synchronized audio experience across the vessel. You can quickly create, edit, and break up groups as needed from any compatible stereo or remote control on the network.

You can use compatible stereos and remote controls, whether they are grouped or not, to adjust the volume of the available speaker zones for any stereo on the network.

You should refer to the installation instructions provided with your stereo when constructing the Fusion PartyBus network.

Creating a Group

Before you can create a group, you must connect multiple compatible stereos to the Fusion PartyBus network. See the installation instructions provided with your stereo for information about installing and configuring the network.

NOTE: There are some limitations and other considerations when using stereos in groups. See [Grouped Stereo Source Considerations, page 22](#) for more information.

1 Select  > **GROUPS**.

TIP: You can hold  from any screen to open the GROUPS menu.

2 Select the name of the stereo you want to be the primary stereo in the group.

3 Select the stereos you want to add to the group.

4 Select **DONE**.

From the source screen, you can select a source from any stereo in the group except a zone stereo, such as the Fusion Apollo SRX400 stereo or any sources that are disabled for use on the Fusion PartyBus network ([General Settings, page 26](#)).

Editing a Group

1 Select  > **GROUPS**.

2 Select the group.

3 Select the stereos you want to add to or remove from the group.

4 Select **DONE**.

Leaving a Group

You can leave the Fusion PartyBus group to play local sources on the stereo.

1 Select  > **GROUPS**.

2 Select the group you want to leave.

3 Select the stereos you want to remove from the group.

4 Select **DONE**.

Grouped Stereo Functions

After you create a group of stereos, additional functions and options are available to all stereos in the group.

- After you create a group, all of the stereos in the group share the same synchronized display.
- You can select a source from any stereo in the group, with a few limitations ([Grouped Stereo Source Considerations, page 22](#)), and the source will play simultaneously on all stereos in the group ([Selecting a Source, page 4](#)).
- You can control playback (such as pausing and skipping tracks) on any stereo in the group, and it will affect all stereos in the group.
- You can adjust the volume for any zone on any stereo in the group.

TIP: When adjusting the volume, you can select ALL to adjust the volume of all the stereos in the group at the same time.

Grouped Stereo Source Considerations

When selecting sources to play over the network, you should observe these considerations.

- A zone stereo, such as the Fusion Apollo SRX400, can create or join a group to control and play sources from other stereos, but it cannot share its sources with the group.
- You cannot share an AirPlay source with grouped stereos. Using AirPlay 2 software, you can play content on multiple stereos on the network, but the stereos must not be grouped.
- You can disable sharing on most sources by changing the GROUP ENABLED setting for the source. When disabled, the source cannot be selected from a grouped stereo ([General Settings, page 26](#)).
- When audio sources are streamed over a data network, there is a slight delay in the synchronized audio that may be noticeable if you are also using an external audio source.
 - If you have a television with an Optical Out connection to a stereo and you continue to use the television speakers, there will be a delay between the audio from the television speakers and the optical audio streamed on the grouped stereos.
 - If you synchronize a radio station and tune that same radio station on a non-networked stereo, there will be a delay between the audio from the non-networked stereo and the audio from the radio station streamed on the grouped stereos.
 - You can remove this delay by changing the GROUP ENABLED setting for the source, but the source cannot be shared with grouped stereos ([General Settings, page 26](#)).

NOTE: You cannot change the settings when a stereo is part of a group. You must remove the stereo from the group before you can change any settings.

Group Synchronization

By default, groups you create are not maintained when you turn off stereos in the group. If you turn off a single stereo added to the group, it leaves the group. If you turn off the primary stereo in the group, the group is dissolved. You can enable group synchronization to preserve group membership for a stereo after turning it off. Group synchronization behaves differently based on how you turn the stereos off and on.

- If you turn a synchronized stereo off and on by using either the power button on the stereo or a physical switch on the ignition wire (the red wire), all of the synchronized stereos in the group turn off and on together. This applies to all of the synchronized stereos in the group, whether or not a stereo is the primary stereo in the group.
NOTE: Selecting ALL OFF from the power menu on a stereo turns off all stereos on the network, even if they are not in a group or have group synchronization enabled.
- If you turn a synchronized stereo off and on using a physical switch on the power wire (the yellow wire), the other synchronized stereos in the group behave differently:
 - If the synchronized stereo is the primary stereo in the group and you turn it off using a physical switch on the power wire, the other synchronized stereos in the group remain on, but leave the group. When you turn the primary stereo back on again, the other synchronized stereos rejoin the group.
 - If the synchronized stereo is not the primary stereo in the group and you turn it off and on using a physical switch on the power wire, all of the other synchronized stereos in the group remain on and grouped, and the stereo rejoins the group when you turn it on again.

Enabling Group Synchronization

You must remove the stereo from an existing group before you can enable the GROUP SYNC setting. You cannot update settings when a stereo is part of a group.

You must enable this setting on each stereo that you want to retain group settings after a power cycle.

- 1 Select  > **SETTINGS**.
- 2 Select **POWER OPTIONS** > **GROUP SYNC**.
The stereo retains group settings after a power cycle.
- 3 Repeat for additional stereos as needed.

NOTE: You must enable GROUP SYNC on all networked stereos for synchronization to work properly.

LED Lighting Control

If you installed a Garmin Spectra™ lighting controller, you can use the stereo to activate and change limited features on connected LED lights. You can quickly turn LED lights on and off, select preprogrammed lighting effects, activate saved scenes, and use AUDIO SYNC to configure lights to change color and brightness to music played on the stereo. If needed, more advanced control and configuration of the lights can be performed using the ActiveCaptain® app or using a compatible chartplotter on the same NMEA 2000 network and marine network as the lighting controller and the stereo. See the owner's manual for the chartplotter for complete instructions.

WARNING

Setting some LED light effects or setting the LED lights to react to music may result in lights flashing at various intervals. Consult your physician if you have epilepsy or are sensitive to bright or flashing lights.

NOTICE

Before you can control any connected lights using the stereo, you must first initialize the lights using a compatible chartplotter on the same NMEA 2000 network as the lighting controller and the stereo. See the installation instructions for the Garmin Spectra lighting controller or the owner's manual for the chartplotter for initialization instructions. If you do not have a compatible chartplotter connected, you can also initialize the lights using the ActiveCaptain app on a mobile device.

Using certain LED colors on your vessel, such as red and green, may violate the laws, regulations, and standards related to the use and/or operation of marine navigation lights. It is the user's responsibility to comply with any such applicable laws, regulations, and standards. Garmin is not responsible for any fines, penalties, citations, or damages that may be incurred due to any such lack of compliance.

Turning LED Lights On and Off

- 1 Select  > **LED CONTROL**.
- 2 Select **LIGHTS** and select the lights or group of lights you want to turn on or off.
- 3 Select **ON** to turn on the lights.
- 4 Select **ON** again to turn off the lights.

Turning on LED Light Effects

WARNING

Selecting some LED light effects may result in lights flashing at various intervals. Consult your physician if you have epilepsy or are sensitive to bright or flashing lights.

The Garmin Spectra lighting controller has a selection of preprogrammed lighting effects that you can turn on using the stereo.

- 1 Select  > **LED CONTROL**.
- 2 Select **LIGHTS** and select the lights or group of lights you want to use a lighting effect.
- 3 Select **EFFECTS** and select one of the preprogrammed lighting effects to start it on the connected lights.

Starting an LED Light Scene

NOTICE

Before you can start an LED light scene using the stereo, you must use a connected chartplotter to create at least one scene. See the owner's manual for the chartplotter for complete instructions.

- 1 Select  > **LED CONTROL** > **SCENES**.
A list of previously-created scenes is shown.
- 2 Select a scene to start.

Setting LED Lights to React to Music

WARNING

Setting LED lights to react to music may result in lights flashing at various intervals. Consult your physician if you have epilepsy or are sensitive to bright or flashing lights.

NOTICE

Before you can set connected LED lights to react to music playing on the stereo, you must use a connected chartplotter to associate a light or group of lights with an audio zone on this stereo. See the chartplotter owner's manual for complete instructions.

- 1 Select  > **LED CONTROL**.
- 2 Select **LIGHTS**, and select the lights or group of lights you want react to music.
- 3 Select **AUDIO SYNC**, and select an option:
 - If you want the lights to react to the intensity of the music playing, select **COLOR BLEND**.
 - If you want the lights to react to the bass and treble frequencies of the music playing, **AUDIO SPECTRUM**.

You must use a connected chartplotter if you want to change the colors used by this feature. See the chartplotter owner's manual for complete instructions.

LED Light Control and Configuration Using the ActiveCaptain App

You can connect your mobile device to a wireless router or wireless access point on the same network as the stereo. When connected to the stereo in this manner, you can use the ActiveCaptain app to configure and control lights connected to a Garmin Spectra LED control module. If the stereo and LED control module are connected to the same NMEA 2000 network as a compatible chartplotter, you should connect the ActiveCaptain app to the chartplotter instead of the stereo so you can use the full features included in the app in addition to the lighting controls. See the owner's manual for the chartplotter for instructions.

NOTE: Before you can connect your mobile device to the stereo, you must connect the stereo to a wireless router using an Ethernet cable.

Getting Started with the ActiveCaptain App

You can connect your mobile device to a wireless router or wireless access point on the same network as the stereo using the ActiveCaptain app. The app provides a quick and easy way for you to configure and interact with the lights connected to a Garmin Spectra LED control module.

1 If necessary, connect the stereo to a network with a wireless router or wireless access point using an Ethernet cable.

2 From the application store on your mobile device, install and open the ActiveCaptain app.

TIP: You can scan this QR code using your mobile device to download the app.

3 Log into the ActiveCaptain app using your Garmin account.

4 Bring the mobile device within 32 m (105 ft.) of the wireless router or wireless access point.

5 In the ActiveCaptain app, select **Connect**.

6 Select the SSID of the wireless router or wireless access point and provide the password, if necessary. The app connects to the wireless network and returns to the main screen.



After the app connects to the wireless router or wireless access point correctly, an option for Lighting is shown on the Boat Apps tab.

Initializing Connected LED Lights Using the ActiveCaptain App

Before you can interact with any connected LED lights using the stereo, you must first initialize the lights by providing information about the type of light source supported by the connected LEDs.

1 If necessary, open the ActiveCaptain app and connect it to the wireless router or wireless access point.

2 In the ActiveCaptain app, select **Settings > Lighting**.

A list of connected LED control modules is shown.

3 Select an LED control module with connected LED lights that you want to initialize and select **Lights**.

A list of all available lights is shown. Any light indicated with a yellow circle must be initialized before it's available for use by the system.

4 Select a connected LED light from the list.

5 Select **Light Types** and select the type of LEDs connected:

- **RGB:** The connected dimmable LEDs support a full range of colors.
- **RGBW:** The connected dimmable LEDs support a full range of colors and high quality white light.
- **CRGBW:** The connected dimmable LEDs support a full range of colors and multiple temperature white light.
- **Single Channel:** The dimmable LEDs support one dedicated color.

TIP: You can select Identify to illuminate the selected light to help identify and test the selected LED type.

6 Repeat this procedure for all connected lights until all of the intended LED lights are initialized.

General Settings

NOTE: When the stereo is in a group, you cannot change the settings on that stereo.

Select  > **SETTINGS**.

NOTE: When a check box is filled, the option is on. When the check box is clear, the option is off.

DEVICE NAME: Sets a name for this device.

LANGUAGE: Sets the language used on the device.

TUNER REGION: Sets the region used by the FM and AM sources.

This setting is also needed to configure DAB and SiriusXM sources.

TELEMUTE: Sets the behavior of the stereo when it detects a signal on the TELEMUTE wire in the wiring harness. This is commonly used to change to the Aux1 source when you hold the button on a Fusion handheld microphone. You can also choose to either mute the audio or change to the Aux1 source when connected to a hands-free mobile phone kit. See your Fusion handheld microphone or hands-free mobile phone kit instructions for more information.

NOTE: This setting does not affect a phone connected to the stereo using Bluetooth technology.

POWER OPTIONS: Adjusts the power settings, such as the GROUP SYNC ([Power Options, page 30](#)).

SEARCHING: Enables Fusion Alpha Search Technology (FAST), which allows you to quickly search for tracks by letter or number. You can select a number to enable the FAST menu if your music device contains more than the selected number of items.

ZONE: Enables you to configure the speaker zones ([Speaker Zone Settings, page 26](#)).

SOURCE: Allows you to enable, disable, and name the sources and groups on the stereo ([Source Settings, page 30](#)).

NETWORK: Enables you to configure the Fusion PartyBus network settings ([Network Settings, page 30](#)).

UPDATE: Updates the stereo or connected devices using the appropriate update file on a connected USB flash drive ([Update Options, page 32](#)).

NOTE: It is not necessary to use this menu if you are updating the software using the Fusion Audio app on a mobile device instead of using an update file loaded onto a USB flash drive ([Updating the Software Using the Fusion Audio App, page 41](#)).

UPDATE > FACTORY RESET: Restores all settings to the factory default values.

ABOUT: Shows the software version information for the stereo and connected accessories.

Speaker Zone Settings

Disabling the Internal Amplifier

If you do not connect speakers directly to zones 1 and 2, you can disable the internal amplifier to reduce power consumption.

1 Select  > **SETTINGS**.

2 Select **ZONE**.

3 Select **INTERNAL AMP ON** to clear the check box.

Setting the Home Zone

The home zone is the speaker zone that you adjust by default when you turn the dial.

1 Select  > **SETTINGS**.

2 Select **ZONE > ASSIGN HOME ZONE**.

3 Select a zone.

Synchronizing the Source and Zone Volume Levels

You can synchronize the volume levels on one or all zones with some source devices, such as a Bluetooth or AirPlay source.

- 1 Select  > **SETTINGS**.
- 2 Select **ZONE** > **PHONE VOLUME SYNC**.
- 3 Select a zone or **ALL**.

When you adjust the volume on the connected source, the volume on the selected zone is also adjusted.

Adjusting the Power-On Volume Limit

By default, when you turn on the stereo, the system automatically reduces the volume to level 12 if it was louder than that when you turned it off. You can adjust this limit if you want to retain a louder volume or limit to a lower volume when you turn on the stereo.

NOTE: This setting affects all zones on the stereo.

- 1 Select  > **SETTINGS**.
- 2 Select **ZONE** > **POWER ON VOLUME LIMIT**.
- 3 Adjust the volume limit.

Maintaining Individual Zone Volume Levels

If you adjust the volume levels of individual zones so that some zones are louder than others, the individual zone volume settings are all affected when you adjust the volume for ALL zones. By default, if you adjust the volume for ALL to 00, this sets of the volume levels for all zones to 00 and resets all individual zone volume adjustments. You can enable the KEEP VOLUME RATIOS option to retain individual zone volume adjustments when you adjust the volume for ALL to 00.

NOTE: This setting applies to volume adjustments on the stereo or a connected ERX remote control only. If you adjust the volume on the stereo using a connected chartplotter or NRX remote control, the volume levels will still be reset.

TIP: For the best results when enabling this setting, you should set the power-on volume limit to 24 ([Adjusting the Power-On Volume Limit, page 27](#)).

- 1 Select  > **SETTINGS**.
- 2 Select **ZONE** > **KEEP VOLUME RATIOS**.

Enabling Automatic Volume Adjustment Based on Speed

- 1 Select  > **SETTINGS** > **ZONE** > **SPEED VS VOLUME** > **ENABLED**.
- 2 If needed, update the settings to select the speed source ([Automatic Volume Control Settings, page 28](#)).

Automatic Volume Control Settings

Select  > **SETTINGS** > **ZONE** > **SPEED VS VOLUME**.

ENABLED: Enables the automatic volume control feature.

SPEED SOURCE: Sets the source that the stereo uses to determine the speed (*Speed Source Information*, page 28).

MAX/MIN SPEED: Sets the expected maximum and minimum speed range for the selected SPEED SOURCE. The MIN setting indicates the speed at which the volume plays at the level you set by turning the dial. The MAX setting indicates the speed at which the volume plays at the highest level set in the VOLUME INCREASE setting.

TIP: You should start by setting these values at the speeds you typically expect from your engine or sensor and adjust them as needed.

VOLUME INCREASE: Sets the total volume increase for each zone when the selected SPEED SOURCE reaches the set maximum speed set in the MAX/MIN SPEED setting. The higher you set this level, the louder the volume will be as you approach the set maximum speed.

NOTE: When the volume increases to adjust for speed, the actual volume output changes but the volume-level indicator bar and number stays the same.

CUSTOM UNITS: Changes the measurement unit used to indicate the vessel or wind speed.

Speed Source Information

Select  > **SETTINGS** > **ZONE** > **SPEED VS VOLUME** > **SPEED SOURCE**.

ENGINE SPEED: Uses the RPM reading provided by a supported NMEA 2000 engine. The volume increases as the engine RPM increases from the set MIN speed to the set MAX speed. If multiple supported engines are connected, the stereo uses the average RPM reading from all engines.

SPEED OVER GROUND: Uses the speed over ground (SOG) reading provided by a supported NMEA 2000 GPS antenna or chartplotter with an internal GPS antenna. The volume increases as the SOG increases from the set MIN speed to the set MAX speed.

SPEED THROUGH WATER: Uses the speed through water (STW) reading provided by a supported NMEA 2000 water-speed sensor. The volume increases as the STW increases from the set MIN speed to the set MAX speed.

WIND SPEED: Uses the wind speed reading provided by a supported NMEA 2000 wind-speed sensor. The volume increases as the wind speed increases from the set MIN speed to the set MAX speed.

Disabling a Zone

You can disable an unused zone and remove it from the audio level pages. When a zone is disabled, you cannot change any of the settings for that zone. You cannot disable zone 1.

- 1 Select  > **SETTINGS**.
- 2 Select **ZONE**.
- 3 Select a zone.
- 4 Select **ZONE ENABLED** to clear the check box.

Setting a Zone Name

You can set a name for a speaker zone to make it easier to identify.

- 1 Select  > **SETTINGS**.
- 2 Select **ZONE**.
- 3 Select a zone.
- 4 Select **ZONE NAME**, and select an option:
 - Select a pre-defined name from the list.
 - Select **CUSTOM NAME**, and enter a unique name for the zone.

Linking Zones

You can link zones 1 and 2 to keep the volume levels synchronized. Adjusting the volume of either of the linked zones affects both zones.

- 1 Select  > **SETTINGS**.
- 2 Select **ZONE > ZONE 2 > LINK TO ZONE 1**.

NOTE: After zones 1 and 2 are linked, you cannot adjust the volume of each zone individually.

Enabling Volume Control of Zone 3 or 4 from a Connected Amplifier

By default the volume of zones 3 and 4 are controlled by the stereo. You can control the volume of these zones using the connected amplifier instead.

- 1 Select  > **SETTINGS**.
- 2 Select **ZONE**.
- 3 Select zone 3 or zone 4.
- 4 Select **VOLUME CONTROL** to clear the check box.

The audio signal from the zone is provided to the amplifier as a fixed-line-level output at maximum volume.

Adjusting the Subwoofer Filter

You can use the subwoofer filter setting to control the subwoofer cutoff frequency for each zone, which can enhance the blend of the sound produced by the speakers and the subwoofer. Audio signals above the selected frequency are not passed to the subwoofer.

NOTE: If a DSP setting has been applied to the zone using the Fusion Audio app, this setting cannot be changed on the stereo.

- 1 Select  > **SETTINGS**.
- 2 Select **ZONE**.
- 3 Select a zone.
- 4 Select **SUB. FREQ..**
- 5 Select a frequency.

Adjusting Additional Audio Settings for a Zone

- 1 Select  > **SETTINGS**.
- 2 Select **ZONE**.
- 3 Select a zone.
- 4 Select one or more options:
 - To limit the maximum volume output of this zone, select **VOLUME LIMIT**, and adjust the level.
 - To adjust the right and left speaker balance of this zone, select **BALANCE**, and adjust the balance.
 - To reduce the power output to the external amplifier associated with this zone, select **EXT. AMP GAIN**, and adjust the gain level.
 - To reduce the power output to the internal amplifier associated with this zone, select **INT. AMP GAIN**, and adjust the gain level.

NOTE: This setting is available only for zones associated with an internal amplifier, typically zones 1 and 2.

- To change the output of this zone from stereo to mono, select **MONO**.

NOTE: The mono setting is useful if a listening position is closer to one speaker than the other and predominantly hear only that channel. The mono setting combines both channels in each speaker in the zone.

Power Options

Select  > **SETTINGS** > **POWER OPTIONS**.

POWER SAVE: Disables the LCD backlight after one minute of inactivity to save battery power.

NRX POWER: Turns on or off the power the stereo provides to optional NRX series wired remote controls not on a NMEA 2000 network ([Configuring an Optional Wired NRX Remote Control, page 34](#)).

GROUP SYNC: Enables the stereo to retain group settings after a power cycle ([Group Synchronization, page 23](#)).

Source Settings

Select  > **SETTINGS** > **SOURCE**, and select the name of the source you want to configure.

NOTE: This menu contains system-wide source settings. Most sources also have source-specific settings. See the sections of this manual for each source for more information about source-specific settings.

Not all options are available for every source on the stereo.

SOURCE ENABLED: Enables and disables the source on this stereo. You may want to disable sources that will never be used on the stereo so they no longer appear on the source-selection screen.

GROUP ENABLED: Enables and disables the sharing of the source when connected to other stereos in a group ([Fusion PartyBus Networking, page 21](#)). You may want to disable sharing for some sources, such as AM, because streaming over the Fusion PartyBus network introduces a small audio lag that is not desirable in some situations.

SOURCE NAME: Changes the name of the source as it appears on this stereo. This also affects how the source appears to other stereos in a group.

Network Settings

NOTE: If a Garmin chartplotter is detected on the network, the stereo automatically switches to GARMIN MARINE NETWORK mode, and all other network settings are disabled.

Select  > **SETTINGS** > **NETWORK**.

DHCP CLIENT: Sets the device as a DHCP client. This is the default setting for all devices that are not configured to be a DHCP server.

STATIC IP: Allows you to set a static IP address for the device ([Setting a Static IP Address, page 31](#)).

DETAILS: Shows information about the network configuration.

ADVANCED: Allows you to configure the DHCP server and reset all network settings for this stereo to the factory default values.

SAVE: Allows you to save changes to the network settings.

Setting the Stereo as a Wired DHCP Server

If you connected more than two network devices together directly or using a network switch or wireless access point and did not install a router, you should configure only one Fusion PartyBus stereo to be a DHCP server.

NOTE: Although the Fusion PartyBus devices can communicate with each other without a DHCP server on the network, the devices take longer to connect to each other when you first turn them on. It is highly recommended to have a properly-configured DHCP server on the network for the best results.

NOTE: If your vessel has a mix of Garmin Marine Network and Garmin BlueNet networks connected through a Garmin BlueNet bridge, all stereos must be connected to the Garmin BlueNet network.

1 Select  > **SETTINGS** > **NETWORK** > **STATIC IP** > **SAVE**.

You must set the stereo to use a static IP address before you can set it as a wired DHCP server.

2 Select **ADVANCED** > **DHCP SERVER** > **DHCP ENABLED** > **SAVE**.

You can configure the IP address range of the DHCP server ([DHCP Settings, page 31](#)).

Setting a Static IP Address

If the stereo is configured as a static IP, it is automatically assigned the IP address of 192.168.0.1. You can change this IP address.

If the stereo is a DHCP client on the network and you do not want the DHCP server to automatically assign an IP address to the stereo, you can set a static IP address.

NOTE: Every device on the network must have a unique IP address. If you select a static IP address that is the same as another IP address on the network, the devices will not work properly.

1 Select  > **SETTINGS** > **NETWORK** > **STATIC IP**.

2 Select an option:

- To set the IP address, select **IP**, and enter the IP address.
- To set the subnet mask, select **MASK**, and enter the subnet mask.

NOTE: The subnet mask must match all other devices on the network to work properly. A typical subnet mask is 255.255.255.0.

- To set the default gateway IP address, select **GATEWAY**, and enter the gateway IP address.

NOTE: The default gateway is typically set as the IP address of the DHCP server on the network.

3 Select **SAVE**.

DHCP Settings

Select  > **SETTINGS** > **NETWORK** > **ADVANCED** > **DHCP SERVER**.

DHCP ENABLED: Sets the device as the DHCP server on the network.

START IP: Sets the first IP address in the IP-address range of the DHCP server.

END IP: Sets the final IP address in the IP-address range of the DHCP server.

Connecting the Stereo to a Garmin Network

NOTE: When you connect the stereo to a Garmin BlueNet network or a Garmin Marine Network, you are limited to using only Garmin and Fusion devices. You will not be able to use third-party routers or other network products with this stereo directly.

You can connect this stereo to a Garmin BlueNet network or a Garmin Marine Network in order to view and control the stereo using a compatible Garmin chartplotter.

NOTE: If a Garmin chartplotter is detected on the network, the stereo automatically switches to GARMIN MARINE NETWORK mode, and all other network settings are disabled.

This stereo is compatible with both Garmin BlueNet devices and Garmin Marine Network devices. For more information about Garmin BlueNet technology, including best practices for constructing a network including both Garmin BlueNet devices and Garmin Marine Network devices, go to garmin.com/manuals/bluenet.

NOTE: If your vessel has a mix of Garmin Marine Network and Garmin BlueNet networks connected through a Garmin BlueNet bridge, all stereos must be connected to the Garmin BlueNet network.

TIP: When the stereo is connected to a Garmin network, you can connect a mobile device to a wireless access point on a connected Garmin chartplotter and use the Fusion Audio app to control the stereo.

1 Determine the best device on the Garmin BlueNet network or the Garmin Marine Network to which you should connect the stereo.

2 Select an option:

- To connect the stereo to a Garmin BlueNet device, use a Garmin BlueNet network to RJ45 adapter cable (sold separately - 010-12531-02).
- To connect the stereo to a Garmin Marine Network device, use Garmin Marine Network to Fusion cables (010-12531-20).

Resetting Network Settings

You can reset all network settings for this stereo to the factory default values.

- 1 Select  > **SETTINGS**.
- 2 Select **NETWORK > ADVANCED > RESET > YES**.

Update Options

NOTICE

Do not turn off the device or disconnect the power during a software update. Turning off the power during a software update may cause the device to become unresponsive.

Depending on your stereo and network connections, you may have multiple software-update options available. Before proceeding with an update, you should examine your devices and connections to determine the most efficient way to proceed (*Software Updates, page 35*).

NOTE:

- The device may restart a few times when updating. This is normal.
- You can program only newer versions of software on the device.

Select  > **SETTINGS > UPDATE**.

UPDATE DEVICES: Updates the stereo using a valid software update file on a connected USB flash drive (*Updating the Software Using a USB Flash Drive, page 38*).

ACCESSORIES > NRX REMOTE: Updates an optional NRX remote connected to the NMEA 2000 port or NMEA 2000 network.

ACCESSORIES > ERX REMOTE: Updates an optional ERX remote connected to the ETHERNET port or the Fusion PartyBus network using a valid software update file on a connected USB flash drive (*Updating the Software Using a USB Flash Drive, page 38*).

ACCESSORIES > DAB MODULE: Updates an optional DAB module connected to the SIRIUS XM port.

SAVE GARMIN DEVICES: Saves connected device information to a connected USB flash drive. This information is required by the Garmin Express™ program when preparing the USB flash drive with the proper software update files.

FACTORY RESET: Resets default settings.

Additional Stereo Control Options



Connecting to a Garmin Watch

For more information about the watch, see the watch manual at garmin.com/manuals.

- 1 Following the instructions in the watch manual, install the Fusion Audio app from the Connect IQ™ store onto the watch.
- 2 On the stereo, select the **BLUETOOTH** source.
- 3 Select  > **BLUETOOTH > CONNECTIONS > DISCOVERABLE**.
The stereo remains discoverable for two minutes.
- 4 Bring the watch within 3 m (10 ft.) of the stereo.
NOTE: Stay 10 m (33 ft.) away from other ANT® devices while pairing.
- 5 Open the Fusion Audio app on the watch.
The first time you open the app on the watch, the watch automatically pairs with and connects to the stereo. If you need to pair to another stereo, in the Fusion Audio app, select **Settings > Pair new**.
- 6 Control the audio playback using the Fusion Audio app on the watch.

After the devices are paired, they connect automatically when they are turned on, within range, and the app is open on the watch.

Connecting to an ARX70 Remote Control

- 1 On the stereo, select the **BLUETOOTH** source.
- 2 Select  > **BLUETOOTH** > **CONNECTIONS** > **DISCOVERABLE**.
- 3 Bring the ARX70 remote control within 10 m (33 ft.) of the stereo.
NOTE: Stay 10 m (33 ft.) away from other ANT devices while pairing.
- 4 On the ARX70 remote control, press and hold  until the status LED starts alternating green and red.
The remote control searches for the stereo. When the remote control pairs successfully, the status LED turns on green briefly and then turns off.

If the remote control cannot find the stereo, the status LED turns on red briefly and then turns off.

Fusion Audio Wireless Remote Control App

You can use the Fusion Audio remote control app on your compatible Apple or Android device to adjust the stereo volume, change the source, control playback, select and manage radio presets, and adjust some stereo settings. You can use the app to set up and configure DSP profiles on the stereo.

The app communicates with the stereo using a wireless connection to the mobile device. You must connect your compatible device to the stereo using Bluetooth technology to use the app.

If the stereo is connected to a network with a Wi-Fi access point, the app can communicate with the stereo using the network for greater range than a Bluetooth connection.

You can connect an Apple device to the stereo using a USB cable to update the stereo software.

For information about the Fusion Audio remote control app for compatible Apple or Android devices, go to the Apple App StoreSM or the Google PlayTM store.

Fusion Stereo Network Connection and Control

When connected using a supported networking method, you can fully control compatible Fusion entertainment systems on compatible multi-function displays installed at the helm, flybridge, or navigation station of the vessel. This provides integrated entertainment control and a less cluttered console.

The connected multi-function display becomes the portal on which you can control all audio on the vessel, no matter where on the vessel the connected stereo is installed. The compatible Fusion stereo can be installed out of sight if space is an issue and users need to access the stereo only to replace removable media.

This device can communicate with a compatible multi-function display using existing industry-standard network connections including Ethernet and Wi-Fi wireless technology.

NOTE: Garmin multi-function displays must be connected via Ethernet.

This device can communicate with a compatible multi-function display using existing industry-standard NMEA 2000 networks.

NMEA 2000 Remote Control and Display

The stereo can be controlled by compatible Fusion wired remote controls installed in the audio zones throughout the vessel. Operating the entertainment system from the remote control is similar to operating it from the main stereo.

Fusion wired remote controls operate over an existing NMEA 2000 network, so wiring the remote controls directly to the stereo is not necessary. All remote controls connected to the same NMEA 2000 network as the stereo can control the stereo.

If your vessel does not have a NMEA 2000 network, you can directly connect a single Fusion remote control or create a Fusion remote control network to connect multiple Fusion wired remote controls directly to the NMEA 2000 connector on the stereo. See the installation instructions provided with your stereo and remote for more information.

You can directly connect a single Fusion remote control or create a Fusion remote control network to connect multiple Fusion wired remote controls directly to the NMEA 2000 connector on the stereo. See the installation instructions provided with your stereo and remote for more information.

The Fusion wired remote control can also serve as an NMEA® display showing NMEA navigation data or vessel performance data from other NMEA devices on an existing NMEA 2000 network. See the instructions provided with your remote control for information on supported NMEA 2000 PGN information.

Configuring an Optional Wired NRX Remote Control

NOTICE

The stereo is configured by default to work with a NMEA 2000 network, and the NRX POWER option should be enabled only when an optional wired NRX remote control is connected directly to the stereo. Enabling this option when the stereo is connected to a NMEA 2000 network may damage other devices on the NMEA 2000 network.

If you connect an optional wired NRX remote control directly to the stereo, and not through a NMEA 2000 network, additional configuration is needed.

- 1 Select  > **SETTINGS** > **POWER OPTIONS**.
- 2 Select an option:
 - If you connected both your stereo and your optional wired remote to a NMEA 2000 network, make sure the **NRX POWER** option is not selected. This enables the optional remote to receive power from the NMEA 2000 network.
 - If you connected the optional wired remote directly to the stereo through the NMEA 2000 connector, select the **NRX POWER** option. This enables the stereo to supply power to the optional remote.

NMEA 2000 Information

NMEA 2000 is the most popular marine standard for data communication within vessels. It has become the standard for sending navigation and engine management data within vessels. Fusion introduces an industry-first product by incorporating NMEA 2000 functionality in its audio remote control devices. This enables the user to monitor relevant NMEA 2000 Parameter Group Number (PGN) data available over the NMEA 2000 network on a connected NRX series remote control.

Appendix

Registering Your Fusion Device

Help us better support you by completing our online registration today.

- Go to garmin.com/account/register.
- Keep the original sales receipt, or a photocopy, in a safe place.

Cleaning the Device

- 1 Dampen a soft, clean, lint-free cloth with fresh water.
- 2 Gently wipe the device.

Software Updates

For best results, you should update the software in all Fusion devices regularly. Some features, such as the Fusion PartyBus group functionality may not work properly unless all connected stereos are using the same software version.

Depending on your stereo and network connections, you may be able to use any or all of these update methods:

- If you have one or more stereos connected to a network with a wireless access point, you can update the software using the Fusion Audio remote control app ([Updating the Software Using the Fusion Audio App, page 41](#)).
- If you prefer to not use the remote control app, you can update the software using a single-stereo update file loaded onto a USB flash drive ([Updating the Software Using a USB Flash Drive, page 38](#)).
- If you have multiple stereos connected using Ethernet cables as part of a Fusion entertainment network, you can update all of the connected stereos using an entertainment package network update file loaded onto a USB flash drive² ([Updating the Software Using a USB Flash Drive, page 38](#)).
- If you have any Garmin Spectra lighting controllers connected to the same NMEA 2000 network as the stereo, you can update the stereo and the lighting controller software using an entertainment package network update file loaded onto a USB flash drive² ([Updating the Software Using a USB Flash Drive, page 38](#)).
- If the stereo is connected to a compatible Garmin chartplotter, you can update the stereo using a network full marine package update downloaded from the Garmin website or from Garmin Express and loaded onto a memory card² ([Network Update Options, page 42](#)).

You can use this table to best determine what update methods are available for your stereo or stereos and find additional information about each type of update.

² A stereo must be running SW version 6.20 or later to receive an update over the network. A stereo must be running SW version 6.40 or later to send software updates to other stereos on the network. Update any stereos individually as needed before trying a network update.

Devices	Available Update Methods	Update Method Details
<ul style="list-style-type: none"> A Fusion Apollo stereo only 	<ul style="list-style-type: none"> Fusion Audio remote control app USB flash drive (single-stereo update) 	None
<ul style="list-style-type: none"> A Fusion Apollo stereo A Garmin Spectra lighting controller connected to the same NMEA 2000 network as the stereo 	<ul style="list-style-type: none"> Fusion Audio remote control app USB flash drive (single-stereo update) USB flash drive (entertainment package network update) 	<ul style="list-style-type: none"> You must use the USB flash drive entertainment package update method to update a connected lighting controller. Updating using the remote control app updates the stereo only, and does not update a connected lighting controller.
<ul style="list-style-type: none"> One or more Fusion Apollo stereos not connected as part of a Fusion entertainment network One or more Garmin Spectra lighting controllers connected to the same NMEA 2000 network as the stereo or stereos 	<ul style="list-style-type: none"> Fusion Audio remote control app USB flash drive (single-stereo update) USB flash drive (entertainment package network update³) 	<ul style="list-style-type: none"> You must use the USB flash drive entertainment package update method to update the lighting controller or controllers. Because the stereos are not connected as part of a Fusion entertainment network, you must update each stereo individually, using either the either USB flash drive method or using the remote control app. Updating using the remote control app updates the stereo only, and does not update a connected lighting controller.
<ul style="list-style-type: none"> Multiple Fusion Apollo stereos connected as part of a Fusion entertainment network with a mix of stereos connected using Ethernet cables and Wi-Fi connections With or without one or more Garmin Spectra lighting controllers connected to the same NMEA 2000 network as at least one of the stereos 	<ul style="list-style-type: none"> Fusion Audio remote control app USB flash drive (single-stereo update) USB flash drive (entertainment package network update³) 	<ul style="list-style-type: none"> You must use the USB flash drive entertainment package update method to update the lighting controller or controllers. Only stereos connected as part of a Fusion entertainment network using an Ethernet cable update at the same time when using the entertainment package network update. Stereos connected using Wi-Fi technology must be updated individually. If you update using the remote control app or USB flash drive single-stereo update, it can update multiple stereos connected as part of a Fusion entertainment network using Ethernet cables as long as they are all the same model. Stereos of different models must be updated individually. The remote control app or USB flash drive single-stereo update does not update a connected lighting controller.
<ul style="list-style-type: none"> Multiple Fusion Apollo stereos connected as part of an entertainment network using Ethernet cables only (no stereos connected using Wi-Fi technology) 	<ul style="list-style-type: none"> Fusion Audio remote control app USB flash drive (single-stereo update) 	<ul style="list-style-type: none"> You must use the USB flash drive entertainment package update method to update the lighting controller or controllers. The entertainment package update method also updates all stereos connected as part of a Fusion entertain-

³ A stereo must be running SW version 6.20 or later to receive an update over the network. A stereo must be running SW version 6.40 or later to send software updates to other stereos on the network. Update any stereos individually as needed before trying a network update.

Devices	Available Update Methods	Update Method Details
<ul style="list-style-type: none"> With or without one or more Garmin Spectra lighting controllers connected to the same NMEA 2000 network as at least one of the stereos 	<ul style="list-style-type: none"> USB flash drive (entertainment package network update⁴) 	<p>ment network using Ethernet cables, regardless of model.</p> <ul style="list-style-type: none"> If you update using the remote control app or a USB flash drive single-stereo update, it can update multiple stereos connected as part of a Fusion entertainment network using Ethernet cables as long as they are all the same model. Stereos of different models must be updated individually. The remote control app or USB flash drive single-stereo update does not update a connected lighting controller.
<ul style="list-style-type: none"> One or more Fusion Apollo stereos connected to a Garmin chartplotter using a wired Garmin BlueNet or Garmin Marine Network connection. With or without a single or multiple Garmin Spectra lighting controllers connected to the same NMEA 2000 network as at least one of the chartplotters or stereos 	<ul style="list-style-type: none"> Memory card using a networked compatible Garmin chartplotter (full marine package network update⁴) Fusion Audio remote control app or USB flash drive (single-stereo update)⁵ 	<ul style="list-style-type: none"> The full marine package update method updates all Garmin devices connected to the wired Garmin BlueNet or Garmin Marine Network and the NMEA 2000 network at one time, including connected stereos and lighting controllers. If you have an NRX remote control or a DAB module connected to the stereo, it is not updated as part of the full marine package update method. You must perform updates to those devices individually (Update Options, page 32). If your stereo or stereos are connected to a Garmin chartplotter, you should perform an update using the full marine package update method on a memory card thorough the chartplotter. It is not recommend to use any other update method with this setup. If your stereo or stereos are not running SW version 6.20 or later, you should disconnect it from the Garmin networked devices and perform a single-stereo update. After this update, you can reconnect the stereo and use the full marine package update method for all future updates.

⁴ A stereo must be running SW version 6.20 or later to receive an update over the network. A stereo must be running SW version 6.40 or later to send software updates to other stereos on the network. Update any stereos individually as needed before trying a network update.

⁵ Not recommended. You should use a full marine package network update if your stereo or stereos are connected to a Garmin chartplotter.

Updating the Software Using a USB Flash Drive

You can update the device software using a USB flash drive. You can prepare a suitable USB flash drive by manually downloading and loading the update files, or you can use the Garmin Express app.

NOTICE

Do not turn off the device or disconnect the power during a software update. Turning off the power during a software update may cause the device to become unresponsive.

NOTE:

- You cannot update the software using a USB flash drive formatted using the NTFS file system. If you encounter problems updating the device, format the USB flash drive using FAT32 and try the update process again.
- The device may restart a few times while updating the software. This is expected behavior.
- You can program only newer versions of software on the device.
- You can download an entertainment package to update all Fusion Apollo stereos connected as part of an entertainment network using Ethernet cables and any Garmin Spectra lighting controllers connected to the same NMEA 2000 network as the stereo⁶.

NOTE: If the stereo you want to update is in a group, you must remove it from the group (*Leaving a Group*, page 21).

- 1 Select an option to prepare the USB flash drive for updating the stereo software:
 - Download the software update manually and load it onto the USB flash drive (*Downloading a Software Update Manually*, page 38).
 - Prepare the USB flash drive using the Garmin Express app (*Downloading a Software Update using the Garmin Express App*, page 39).
- 2 After you prepare the USB flash drive with the software-update files, insert the USB flash drive into the stereo and use the stereo interface to proceed with the update (*Updating the Software from a Prepared USB Flash Drive*, page 40).

Downloading a Software Update Manually

You can download the proper update file for your stereo, stereo accessory, or applicable connected entertainment devices from the Garmin website and manually prepare a USB flash drive to update the stereo.

- 1 Select an option:
 - If you want to download the single-stereo USB software update or an accessory software update file, go to the page for your stereo or stereo accessories on support.garmin.com.
 - If you want to download the entertainment package to update all Fusion Apollo stereos connected as part of an entertainment network using Ethernet cables, and any Garmin Spectra lighting controllers connected to the same NMEA 2000 network as the stereo, go to garmin.com/support/software/marine/.
- 2 Download the stereo update file, the accessory update file, or the entertainment package update file.
- 3 Insert a properly-formatted USB flash drive of sufficient size into your computer.
- 4 Extract the contents of the .zip file to the root of a USB flash drive.
The contents of the software update are contained in a folder named **Garmin**.
- 5 Eject or safely remove the USB flash drive from the computer.

Install the update on the stereo (*Updating the Software from a Prepared USB Flash Drive*, page 40).

⁶ A stereo must be running SW version 6.20 or later to receive an update over the network. A stereo must be running SW version 6.40 or later to send software updates to other stereos on the network. Update any stereos individually as needed before trying a network update.

Downloading a Software Update using the Garmin Express App

You should use a blank USB flash drive for updates. The update process erases the content and reformats the USB flash drive.

- 1 Turn on the stereo.
- 2 Insert the USB flash drive into the USB port on the stereo.
- 3 Select  > **SETTINGS** > **UPDATE** > **SAVE GARMIN DEVICES**.
The stereo writes a small file on the USB flash drive that is used by the Garmin Express app to identify the stereo and connected devices and download the appropriate update file.
- 4 After about ten seconds or more, remove the USB flash drive from the stereo.
- 5 If necessary, install the Garmin Express app on your computer (*Installing the Garmin Express App on a Computer, page 39*).
- 6 Open the Garmin Express app on your computer.
- 7 Insert the USB flash drive into the computer.
- 8 If available, select your vessel and device or select the option to add a device by reading the USB flash drive.
- 9 If updates are available, select **Software Updates** > **Continue**.
- 10 Read and agree to the terms.
- 11 Select the drive letter for the USB flash drive.
- 12 Review the reformat warning, and select **OK**.
- 13 Wait while the software update is copied to the USB flash drive.
NOTE: Copying the update file onto the USB flash drive may take from a few minutes up to a few hours.
- 14 When the process is complete, close the Garmin Express app.
- 15 Eject or safely remove the USB flash drive from the computer.

Install the update on the stereo (*Updating the Software from a Prepared USB Flash Drive, page 40*).

Installing the Garmin Express App on a Computer

You can install the Garmin Express app on a Windows® or Mac® computer.

- 1 Go to garmin.com/express.
- 2 Select **Download for Windows** or **Download for Mac**.
- 3 Follow the on-screen instructions.



Updating the Software from a Prepared USB Flash Drive

Before you update the software, you must load the software update files onto a suitable USB flash drive either manually ([Downloading a Software Update Manually, page 38](#)) or by using the Garmin Express app ([Downloading a Software Update using the Garmin Express App, page 39](#)).

NOTICE

Do not turn off the stereo or disconnect the power during a software update. Turning off the power during a software update may cause the stereo to become unresponsive.

NOTE: The stereo may restart a few times while updating the software. This is expected behavior.

- 1 Turn on the stereo.
- 2 After the stereo boots fully, insert the USB flash drive into the USB port.
NOTE: In order for the update prompt to appear automatically, you must allow the device to fully boot before inserting the USB flash drive.
- 3 If you are prompted to update the software automatically, select **Install Now** to start the update and skip the next step.
- 4 If the update prompt does not appear automatically, select an option:
 - To update the stereo software, select  > **SETTINGS** > **UPDATE** > **UPDATE DEVICES**.
 - To update accessories connected to the stereo, select  > **SETTINGS** > **UPDATE** > **ACCESSORIES** and select the name of the accessory you want to update.

NOTICE

To ensure all accessories are updated properly, you should update the stereo software first, then update the accessories.

- 5 Wait several minutes while the update process completes.
TIP: When using a single-stereo update, if you have multiple stereos of this model connected as part of an entertainment network using Ethernet cables, they are all updated at the same time⁷. If you have multiple stereos of different models, you must update each separately. Using an entertainment package instead updates all connected Fusion Apollo stereos, regardless of model.
- 6 Leave the USB flash drive in place while the stereo updates.
The stereo may reboot multiple times during the update process.
- 7 When prompted, select **RESTART** to finalize the update process.
- 8 After the stereo fully boots after restarting, remove the USB flash drive.
NOTE: If the USB flash drive is removed before the device restarts fully, the update is not complete.

⁷ A stereo must be running SW version 6.20 or later to receive an update over the network. A stereo must be running SW version 6.40 or later to send software updates to other stereos on the network. Update any stereos individually as needed before trying a network update.

Updating the Software Using the Fusion Audio App

If the stereo is connected to a Fusion PartyBus network with a Wi-Fi access point, you can update the stereo software using the Fusion Audio app, available for compatible Apple or Android on the Apple App Store or the Google Play store.



If you have a compatible Apple device, you can use a Lightning to USB sync cable (sold separately) connected to the USB port on the stereo and to your Apple device to update the stereo software through the Fusion Audio app.

NOTICE

Do not turn off the stereo or disconnect the power during a software update. Turning off the power during a software update may cause the device to become unresponsive.

NOTE: If the stereo you want to update is in a group, you must remove it from the group (*Leaving a Group*, page 21).

NOTE:

- The stereo may restart a few times while updating the software. This is expected behavior.
 - You can program only newer versions of software on the stereo.
- 1 If necessary, connect your mobile device to the stereo using one of these methods:
 - Connect your mobile device to the stereo using a Bluetooth connection.
NOTE: You can use a Bluetooth connection to access the stereo information and allow the app to download an update, but you must switch to a Wi-Fi connection to transfer the update to the stereo at the appropriate time. You cannot update the stereo using only a Bluetooth connection.
 - Connect your mobile device to a Wi-Fi access point on the same Fusion PartyBus network as the stereo.
 - If you have a compatible Apple device, you can use a Lightning to USB sync cable (sold separately) to connect your device to the USB port on the stereo.
 - 2 Open the Fusion Audio app, and verify that you can see the stereo in the app.
 - 3 If your mobile device is connected to a Wi-Fi access point on the Fusion PartyBus network, disconnect the mobile device from the Wi-Fi access point, and connect it to a different Wi-Fi network with internet access or to the wireless mobile data connection from your carrier.
NOTE: You must connect your mobile device to the internet in order to download the necessary software update files.
TIP: If your Fusion PartyBus network is presently connected to a router with a modem or SIM card that provides internet access, you can leave your mobile device connected to the network instead of disconnecting and using the wireless mobile data connection from your carrier to download the update files.
 - 4 In the Fusion Audio app, select  > **GENERAL** > **Software Update**.
 - 5 Select the **Online Software Update**.
The app downloads the software update file.
 - 6 After the app finishes downloading the update file, reconnect the mobile device to a Wi-Fi access point on the Fusion PartyBus network.
NOTE: If you have an Apple device, you can use a Lightning to USB sync cable (sold separately) to connect your device to the stereo instead of using a Wi-Fi connection.
 - 7 If necessary, in the Fusion Audio app, reconnect to the stereo.
 - 8 If necessary, select  > **GENERAL** > **Software Updates** > **Online Software Update**.
The app transfers the software update to the stereo over the Wi-Fi connection, the stereo updates the software, and then it restarts.
TIP: If you have multiple stereos of this model connected as part of an entertainment network using Ethernet cables, they are all updated at the same time⁸. If you have multiple stereos of different models, you must update each separately.

⁸ A stereo must be running SW version 6.20 or later to receive an update over the network. A stereo must be running SW version 6.40 or later to send software updates to other stereos on the network. Update any stereos individually as needed before trying a network update.

Network Update Options

When connected to the same Garmin BlueNet network or Garmin Marine Network as a compatible Garmin chartplotter, you can update your compatible Fusion stereos and accessories from the chartplotter.

You can perform a Garmin network update which updates all of the of Garmin and Fusion devices connected to the network.

Updating the Software as Part of a Garmin Network Update

If the stereo is connected to the same Garmin BlueNet network or Garmin Marine Network as a compatible Garmin chartplotter, you can perform a network update on the chartplotter to update all of the connected Garmin devices and Fusion Apollo stereos.

NOTE: A stereo must be running software version 6.20 or later to receive an update over the network. If your stereo is running an earlier software version, you should disconnect it from the network and update it using a USB flash drive before reconnecting and trying a network update.

NOTE: If you have an NRX remote control or a DAB module connected to the stereo, it is not updated as part a marine network update. You must perform updates to those devices individually (*Update Options, page 32*).

- 1 If needed, go to garmin.com/manuals and locate the latest version of the owner's manual for your connected chartplotter.
- 2 Go to garmin.com/support/software/marine/ to download the latest marine update .
You must download the update and install it using a memory card on the chartplotter. Updating the marine network using the ActiveCaptain app does not update connected Fusion Apollo stereos.
- 3 Follow the directions in the chartplotter owner's manual for performing a network update.
The software is updated on all of your connected devices, including the stereo.

Troubleshooting

The stereo does not respond to key presses

- Hold  until the stereo turns off, and turn it on again to reset the stereo.
- Disconnect power to the stereo for two minutes to reset the stereo.

My Bluetooth audio is interrupted by short breaks

- Ensure the media player is not covered or obstructed.
Bluetooth technology performs best with line-of-sight operation.
- Bring the media player within 10 m (33 ft.) of the stereo.
- Turn off the **DISCOVERABLE** setting after pairing a Bluetooth device to the stereo.

The stereo does not display all song information from my Bluetooth source

The availability of song information such as song title, artist name, track duration, and album cover artwork depends on the capability of the media player and music application.

Network Troubleshooting



If you cannot see or connect to Fusion Apollo devices on the network, perform these steps.

- Verify that all Fusion Apollo stereos, remote controls, network switches, routers, and wireless access points are connected to the network and turned on.
- Verify that only one device, either a stereo or a router, is configured as a DHCP server. If you are connected to a Garmin chartplotter using a wired Garmin BlueNet or Garmin Marine Network connection, it acts as the DHCP server for the network and no connected stereo should be configured as a DHCP server.
- Change the channel on your router or wireless access point to test for and correct interference. You may experience wireless interference if there are many nearby wireless access points.
- Disconnect Bluetooth devices to test for and correct interference. Connecting a Bluetooth device to a stereo configured as a wireless access point or client may reduce wireless performance.
- If you configured static IP addresses, verify that every device has a unique IP address, that the first three sets of numbers in the IP addresses match, and that the subnet masks on every device are identical.
- If you have made configuration changes that might be causing networking issues, reset all network settings to the factory default values.
- If you connected the Fusion Apollo device to a Garmin chartplotter using a wired Garmin BlueNet or Garmin Marine Network connection, the network settings on the device should change automatically to **GARMIN MARINE NETWORK**.

If the network settings do not change as expected, reset the network settings on the device ([Resetting Network Settings, page 32](#)).

Network Status Icons

A network-status icon is shown on some screens of the stereo. You can refer to this table to understand the appearance of the icon and help diagnose issues with the Fusion PartyBus network.

	The stereo is configured for a wired network connection and connected to a wired network using an Ethernet cable.
	The stereo is configured for a wired network connection, but cannot detect the wired network. An Ethernet cable may not be connected or there may be other problems with the network.

Software Update Troubleshooting

If a stereo software update you downloaded from the Garmin website does not complete successfully, perform these steps.

- Make sure the update file you downloaded is intended for the stereo model you are updating. Only software update files intended for the specific stereo will update the stereo.
- Make sure the update file is a newer version than what is presently installed on the stereo. Only newer software update files can be installed on a stereo.
- Make sure the update file was extracted from the .zip file and loaded onto the root of the USB flash drive. When properly prepared, the USB flash drive will have a directory named **Garmin** containing the update files.
- Make sure the USB flash drive is formatted using the FAT32 file system. The stereo will not apply an update from a USB flash drive formatted using the NTFS file system.
- If the stereo is part of a Fusion PartyBus network group, remove it from the group before starting the update.

The stereo updates successfully, but a Garmin lighting controller does not

If you are trying to update the stereo and a Garmin lighting controller, or to update only a Garmin lighting controller and the software update does not complete successfully, perform these steps.

- Make sure you downloaded the **Entertainment Package** version of the update file from the Garmin website. Only the Entertainment Package updates a Garmin lighting controller, as the stereo update file updates only the stereo.
- Make sure the stereo is connected to the same NMEA 2000 network as the Garmin lighting controller. The stereo communicates with the lighting controller over the NMEA 2000 network only.
- Make sure the NMEA 2000 network and the Garmin lighting controller are both receiving power and functioning properly before starting the update.

The stereo does not update as part of a Garmin network update

If you are attempting to update a stereo or stereos using a Garmin chartplotter on a network, and the stereo software update does not complete successfully, perform these steps.

- Make sure that the stereo or stereos you want to update over the network are using software version 6.20 or later. If any connected stereos are using an earlier software version, you must update the stereo individually using a USB flash drive or the Fusion app before it can be included in a network update.
- If the network update fails the first time, try it again before further troubleshooting.
- Try disconnecting any Bluetooth devices and try the update again.
- Make sure the stereo is connected properly to the Garmin chartplotter using an Ethernet cable.
- If your network contains both a Garmin BlueNet chartplotter and Legacy Garmin Marine Network devices, make sure the stereo is connected to either the Garmin BlueNet chartplotter or a Garmin BlueNet 20 switch. See garmin.com/manuals/bluenet for more information.
- Make sure that all stereos connected to the network are set to **GARMIN MARINE NETWORK** as the network type.
- If you cannot change the network type, reset the network settings on the stereo (*Resetting Network Settings, page 32*).

The stereo keeps locking up when connected to an Apple device

- Press and hold the power button to reset the stereo.
- Reset the Apple device. Go to www.apple.com for more information.
- Make sure you have the latest version of iTunes® and the latest operating software on your Apple device.

The stereo is not finding my connected Apple device

- Make sure your Apple device supports Interface Accessory Protocol 2 (iAP2). This stereo is not compatible with iAP1 devices.
- Make sure you have the latest version of iTunes and the latest operating software on your Apple device.
- Make sure you have the latest version of the Fusion Audio application on your Apple device.
- Reset the Apple device.
Go to apple.com for more information.
- Contact your Fusion dealer or go to support.garmin.com.

My Apple AirPlay audio is interrupted by short breaks

- Make sure the Apple device is not covered or obstructed.
- Make sure the Apple device has a good connection to the same Wi-Fi network as the stereo.
- Make sure the Apple device is not connected to the stereo using Bluetooth technology and Wi-Fi. Using both a Bluetooth and a Wi-Fi connection may cause playback interruptions.

Specifications

Weight	750 g (26.5 oz.)
Water rating	IEC 60529 IPX6 and IPX7 (front of stereo only, when properly installed) ⁹
Operating temperature range	From 0 to 50°C (from 32 to 122°F)
Storage temperature range	From -20 to 70°C (from -4 to 158°F)
Input voltage	From 10.8 to 16 Vdc
Current (max.)	15 A
Current (muted)	Less than 700 mA
Current (off)	Less than 200 mA
Fuse	15 A mini blade-type
NMEA 2000 LEN @ 9 Vdc	1 (50 mA)
Bluetooth wireless range	Up to 10 m (30 ft.)
ANT wireless range	Up to 3 m (10 ft.)
Wireless frequencies/protocols	Bluetooth 2.4 GHz @ from 13.29 dBm nominal ANT 2.4 GHz @ from 6.92 dBm nominal
Compass-safe distance	20 cm (7.87 in.)

On-board, Class D amplifier

Output music power per channel	4 x 70 W max. 2 ohm
Total output peak power	280 W max.
Output power per channel	4 x 43 W RMS at 14.4 Vdc input, 2 ohm, 10% THD ¹⁰ 4 x 26 W RMS at 14.4 Vdc input, 4 ohm, 10% THD ¹⁰
Line output level (max.)	5.5 V (peak to peak)
Aux input level (typical)	1 V RMS

Tuner frequencies

Tuner	Europe and Australasia	USA	Japan
FM radio frequency range	87.5 to 108 MHz	87.5 to 107.9 MHz	76 to 95 MHz
FM frequency step	50 kHz	200 kHz	50 kHz
AM radio frequency range	522 to 1620 kHz	530 to 1710 kHz	522 to 1620 kHz
AM frequency step	9 kHz	10 kHz	9 kHz

⁹ The device withstands incidental exposure to water of up to 1 m for up to 30 min, and is protected against powerful jets of water. For more information, go to www.garmin.com/waterrating.

¹⁰ The stereo may limit the output power to prevent the amplifier from overheating, and to maintain the audio dynamics.

Stereo Dimension Drawings

Side Dimensions

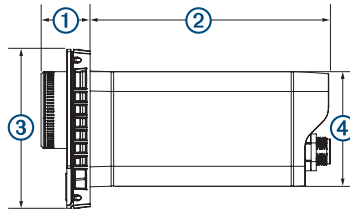

①	21 mm (0.83 in.)
②	102 mm (4.0 in.)
③	68 mm (2.68 in.)
④	49 mm (1.93 in.)

Top Dimensions

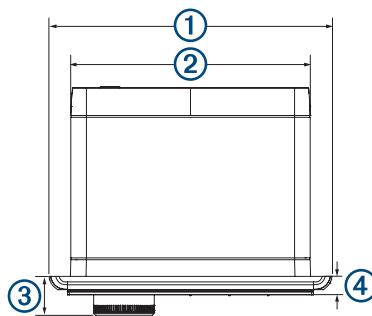

①	157 mm (6.18 in.)
②	130 mm (5.10 in.)
③	21 mm (0.83 in.)
④	10 mm (0.39 in.)

